

Exit

Index

General

[Introduction](#)

Level 1 Libraries

(For all TommySoftware® applications)

[Electrical Engineering #1](#)

[Electronics](#)

[Electrical Installation](#)

[Digital Information Processing](#)

[Process Engineering](#)

[Valves](#)

[Heating](#)

[Chemistry Laboratory Equipment #1](#)

[Chemistry Laboratory Equipment #2](#)

[Chemistry Laboratory Equipment #3](#)

[Furniture #1](#)

[Furniture #2](#)

[Hydraulics & Pneumatics](#)

[Environment & Ecology](#)

[Landscape Design](#)

[Electrical Engineering #2](#)

[Steel Sections](#)

Level 3 Libraries

(For TommySoftware® CAD/DRAW 3 and CAD/DRAW 4 only)

Screws

[Screws DIN 912](#)

[Screws DIN 931](#)

[Screws DIN 933](#)

[Screws DIN 7968](#)

[Screws DIN 7991](#)

[Screw Heads](#)

[Nuts](#)

[Profile](#)

Introduction

TommySoftware® is pleased to announce a comprehensive range of symbol libraries for serious users of all TommySoftware® CAD and graphic packages. This catalogue lists the full range of symbols in each library although for space reasons we are only illustrating a representative sample from each.

Note that for technical reasons the sample illustrations shown here will not display or print with the accuracy or definition of the original symbols when used in the TommySoftware® application. Specifically some lines will appear jagged, especially on low resolution displays, and curves may not be shown accurately. The samples are intended purely to give you an idea of the libraries contents. Each symbol is an accurate, high definition scale drawing in its own right and has been produced by professionals for TommySoftware®, to industrial standards where appropriate.

Use of the appropriate symbol library for your particular field will save you a considerable amount of time and will greatly enhance the quality of your work. Professional quality drawings will become even easier!

While it is believed that all information given in this catalogue is correct, TommySoftware® does not make any claims regarding the accuracy of the information given, and accepts no responsibility for any consequence of its use or of the products referred to.

No part of this catalogue may be reproduced or transmitted in any form or by any means, electronic or mechanical, without the express written permission of TommySoftware®. The only exception to this is that individuals may make backup copies of the disk on which they received this catalogue, and may also make copies for use by their friends or colleagues, providing that all files supplied are copied in their entirety and unchanged and provided that no charge is made.



North America, Inc.

648 Ashbury Street
San Francisco, CA 94117
U. S. A.

Phone 1-800-275-9406
Phone (415) 522 0612
Fax (415) 522 0287

CompuServe GO TOSOENG

Internet

sales@tommysoftware.com (Sales)
support@tommysoftware.com (Technical Support)
http://www.tommysoftware.com (World Wide Web)

Germany

Selchower Straße 32
D-12049 Berlin
Germany

Phone +49 30 621 5931

Fax +49 30 621 4064

CompuServe GO TOSOGER

Electrical Engineering #1

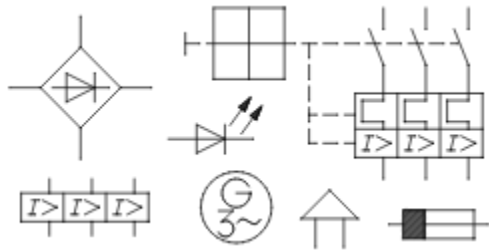

Library Contents

1 3 5
1 3 5 ; 2 4 6
1 3 5 ; 2 4 6 make contact with active connection
2 4 6
single-celled accumulator
amperemeter
drive by pressure
drive by piston
drive by force
drive by float
rotary bi-directional motion
rotary uni-directional motion
straightline bi-directional motion
straightline uni-directional motion
blocking bi-directional motion
blocking uni-directional motion
three-pole bimetal
single-pole bimetal
bridge rectifier (simplified)
diode
LED diode
three-phase bridge rectifier
three-phase generator
three-phase motor
three-phase transformer delta/star
three-phase transformer Yd5
choke form 1
choke form 2
trace with mechanical operating mechanism
treadle operation
generator
direct current generator
direct current motor
removable manual drive (socket wrench box-spanner)
manual drive
manual drive (rotate)
manual drive (press)
manual drive (trip)

manual drive (pull)
horn
electrically operated pulse counter
inductance form 1
inductance form 2
inductance screened
inductance with magnetic core
inductance with magnetic core and air gap
inductance with magnetic core, variable capacitor
disconnected plug-and-socket connector
connected plug-and-socket connector
signal lamp
signal lamp, blinking
ground
measuring instrument, recording
measuring instrument, indicating
measuring instrument with double-sided swing carrier
motor
motor 3 ph
three-pole motor-protection circuit breaker
NPN-transistor
NTC
break contact
break contact, lagging
photoresistor
PNP-transistor
potentiometer
PTC
catch
relay coil
relay coil with operated lag
relay coil with two opposingly operated windings
relay coil with two similarly operated windings
relay coil operating wattmeter
retentive-type relay
switching transient with electromechanical release
make contact
triple make contact
leading make contact
stepping motor
contactor coil
fuse
fuse with identification of the line side
siren
circuit breaker
coil form 1
coil form 2
plug socket
contact pin

plug-and-socket connector with pin and socket
impulse relay
latch relay
signal generator
thyristor
two winding transformer
two winding transformer with shield
three winding transformer
transformer with centre tapping off a winding (06-10-04)
auto-transformer
disconnection
TRIAC
surge arrester
three-pole overvoltage tripping piece
single-pole overvoltage tripping piece
clock
secondary clock
master clock
detachable connection (e.g. screwed)
undetachable connection (soldered)
bi-directional delay
uni-directional delay
voltmeter
alternating current generator (1 phase)
alternating current motor (1 phase)
alternating current
alternating current meter 1ph form1
alternating current meter 1ph form2
alternating current meter 1ph 2tariff form1
alternating current meter 1ph 2tariff form2
alternating current meter 3ph form1
change over contact
change over contact without break
call bell
winding form 1
winding form 2
resistance
resistance, variable
resistance, variable nonlinear
bi-directional wiper
uni-directional wiper
electromechanical register

(131 symbols)

Electronics

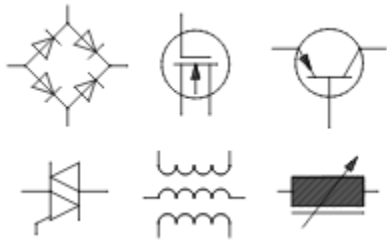

Library Contents

single-celled accumulator
three-celled accumulator battery
aerial
bridge rectifier (explicitly)
bridge rectifier (simplified)
diac
diode
diode, backward
diode, breakdown
diode, capacitance
diode LED
diode, lightsensitive
diode tunnel
z diode
choke form 1
choke form 2
ferrite - bead
FET IE - 2 gates with N channel and substrate joint
N channel junction FET
P channel junction FET
depletion type FET N channel
depletion type FET P channel
rectifier
smoothed direct voltage
unsmoothed direct voltage
direct voltage transformer
hall generator with 4 connections
receiver
ideal power source
ideal current source
electric operated pulse counter
inductance form 1
inductance form 2
inductance with magnetic core
inductance with magnetic core, variable
capacitor
capacitor, adjustable
electrolytic capacitor - polar

electrolytic capacitor - nonpolar
capacitor, polar
capacitor, variable
loudspeaker
LDR
conductor joint, splice
signal lamp
signal lamp, blinking
ground
ground
measuring instrument, recording
measuring instrument, indicating
microphone
shunt resistance
negative impulse
negative step function
NPN transistor
NPN transistor
NPN transistor, collector connected with casing
NPN phototransistor
break contact
photonic cell
photoresistor
PNP phototransistor
PNP transistor
PNP transistor
PNP transistor, collector connected with casing
positive impulse
positive step function
potentiometer
diagnostic flag
sawtooth
make contact
fuse
coil form 1
coil form 2
thyristor
diode thyristor reverse blocking
diode thyristor reverse conducting
triode thyristor bidirectional
triode thyristor reverse blocking
triode thyristor reverse blocking P gate
two winding transformer
two winding transformer with shield
three winding transformer
transformer with centre tapping off a winding (06-10-04)
transformer with variable coupling
auto transformer
TRIAC
clock
secondary clock

master clock
converter
unijunction transistor, N-type
unijunction transistor, P-type
detachable connection (e.g. screwed)
undetachable connection (soldered)
amplifier form 1
amplifier form 2
alternating converter
alternating current
alternating current impulse
change over contact
call bell
winding form 1
winding form 2
resistance
resistance, variable
resistance, variable nonlinear
resistance, lightsensitive

(108 symbols)

Electrical Installation

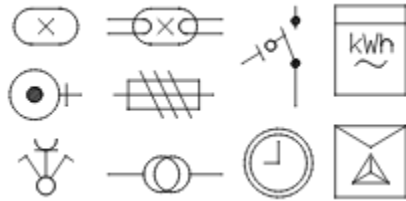

Library Contents

single-celled accumulator
amperemeter
aerial socket
oven
choke
simple socket
simple socket double
electrical appliance
electrical appliance possible to switch
electric cooker
discharge lamp
voltage-operated earth-leakage trip
current-operated earth-leakage circuit breaker
telecommunication socket
deep-fat fryer
dishwasher
boiler
horn
simple horn
infrared grill
conduit
air conditioning equipment
kitchen machine
cooling device
lighting
lighting for discharge lamp
lighting with switch
lighting with additional pilot lamp
panic lighting
lighting possible to darken
flourescent lamp with preheating (explicitly)
flourescent lamp with preheating (simple)
electric ventilator
ground
motor
motor-protection circuit breaker
break contact
plaster
switch 1/1 single-pole circuit breaker

switch 1/1 with earthing-contact socket outlet
switch 1/2 two-pole circuit breaker
switch 1/3 three-pole circuit breaker
switch 4/1 single-pole gang switch
switch 5/1 single-pole set switch
switch 5/1 with earthing-contact socket outlet
switch 6/1 single-pole two-way switch
switch 6/1 with earthing-contact socket outlet
switch 7/1 single-pole cross switch
switch
three-pole switch
flashlight
earth-contact socket outlet
double earth-contact socket outlet
protective switch with thermal release
coil contactor
fuse
three-pole fuse
siren
simple siren
plug socket
socket
contact pin
plug-and-socket connector with pin and socket
star-delta switch
impulse relay
signal generator
simple signal generator
momentary-contact switch
momentary-contact switch with internal lighting
deep freezer
transformer
disconnection
door opener
surge arrester
overcurrent protection switch
three-pole overcurrent protection switch
clock
secondary clock
master clock
transposer
undervoltage protection switch
series reactor
electric hot plate
washing machine
washer dryer
alternating current
alternating current meter 1ph form1
alternating current meter 1ph form2
alternating current meter 1ph 2tariff form1
alternating current meter 1ph 2tariff form2

alternating current meter 3ph form1
change over contact
call bell
simple call bell
resistance
meter

(98 symbols)

Digital Information Processing

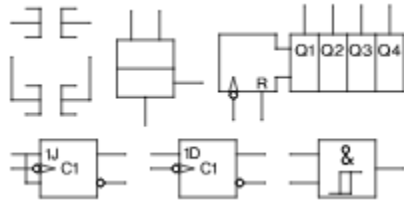

Library Contents

processing (logic diagram)

AND

AND

AND (contact plan)

AND (Schmitt-Trigger)

outlet (logic plan)

outlet (contact plan)

instruction list - form

instruction (logic plan)

d flipflop

exklusive NOR (equivalence)

exklusive NOR (non-equivalence)

impulse generator

JK flipflop edge-triggered

monoflop

NAND

NAND (contact plan)

NAND (Schmitt-Trigger)

NOR

NOT (Inverter)

OR

OR

OR (contact plan)

OR seperately (contact plan)

RS flipflop

RS storage

RS storage (R of prime importance)

reset (contact plan)

set (contact plan)

T flipflop

timer (timing stage)

truth tables

meter, 4 bit, binary

(33 symbols)

Process Engineering

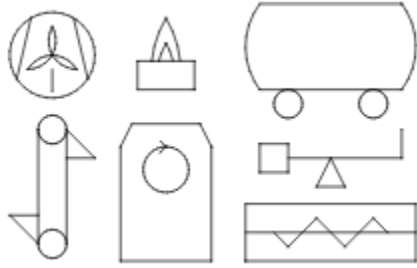

Library Contents

separator
dry separator
settler
exhaust hood
activated carbon filter
anchor agitator
machine drive
axial flow compressor
jaw crusher
band-pass filter for fluids
conveyor belt
belt dryer
conveying weigher
bucket elevator
basin
tank
tank with exchangeable bottoms
tank with plane cover
tank with fixed bed
tank with fluid bed
tank with convex cover
tank with convex bottoms
tank with half-pipe coil
tank with conical bottoms
jacked tank
tank with floating roof
open tank with conical bottoms
tank with full-pipe coil
flat paddle mixer
plate column
ground weigher
crusher
burner
weighing bridge
container for solid, liquid, gaseous substances
steam boiler
decanter

rotary dryer
rotary slide valve vacuum pump
rotary slide compressor
rotary plate
rotating drum dryer
concentrator
electrolysis-cell
electromagnetic separator
electric motor
electrostatic separator
eccentric screw pump
flare for gases
barrel
fixed-bed filter
firing
filter plant
filter press
centrifugal separator
fluidized bed dryer
liquid filter
liquid-piston rotary vacuum pump
liquid-piston rotary compressor
fluid filter
ground conveyor
machine for shaping
gas filter
automatic gas filter
gas cylinder
gas mill
gas-mechanical filter
thread
gate paddle agitator
hammer crusher
hammer mill
heating
hurdle dryer
rotary hurdle dryer
reciprocating membrane compressor
reciprocating pump
piston vacuum pump
reciprocating compressor
impeller agitator
industrial furnace
ion exchange filter
chimney
drying chamber
box carriage
cone crusher
candle filter
kettle carriage
chain conveyor

column
compressor
centrifugal pump
centrifugal mixer
cross-blade agitator
cooling tower
cooling
spherical tank
air filter
membrane pump
membrane vacuum pump
mixer
mill
wet separator
vacuum filter
pelletizing disc
plate heat exchanger
flat car
impact separator
impact breaker
impact mill
propeller agitator
pump
centrifugal ventilator
rake
shower cooler
turbo-dryer
gilled tube heat exchanger
gilled tube heat exchanger with ventilator
roller dryer
rotor type dust collector
rotary compressor
rotary compressor
agitator
sack
rotating disc filter
disc impeller mixer
ship
bag filter
beater mill
screw conveyor
screw extruder
chimney
drying cabinet
jack screw trunnion pump
screw compressor
reciprocal pusher centrifuge
bed filter
bed filter for gases
gravitation separator
vibrating conveyor

vibrating mill
vibrating trough
vibrating tube
sifter
screening machine
screening machine with two screens
screen screw-centrifuge
grading apparatus
injection
stamping press
continious conveyor
ejection pump for fluids
injection mill
jet compressor
extrusion press
tank carriage
pocket filter for gases
tumbling dryer
disc seperator
disc dryer
disc centrifuge
fluid entrainment vacuum pump
dryer
drum
rotating barrel filter
turbine
turbine agitator
turbo vacuum pump
turbo compressor
unpacked storage
vacuum pump
ventilator
venturi-seperator
venturi-scrubber
compressor
displacement vacuum pump
displacement compressor
displacement pump
magnifying device
solid jacked screw centrifuge
scale
roots pump
heat exchanger with crossing of flow lines
heat exchanger without crossing of flow lines
roll crusher
roller mill
roller press
helical ribbon agitator
whirl bed dryer
gear-type pump
bucket wheel

centrifuge
centrifuge with sieve casing
centrifuge with solid jacket
crusher
spray dryer
feeder for solid substances
cyclone

(196 symbols)

Valves

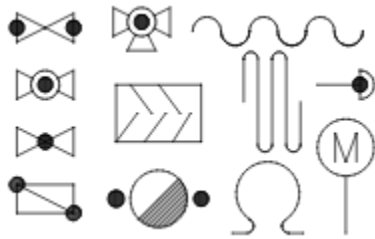

Library Contents

stopping device
angle pattern stopping device
stopping device plugged in
stopping device flanged
stopping device screwed
stopping device welded
stop cock
angle pattern stop cock
conical stop cock
angle pattern conical stop cock
stopping ball cock
angle pattern stopping ball cock
slide valve
angle pattern block valve
block valve
ventilation system device
curved bursting disc
curved bursting disc
blank flange
blind disc
protective cap against fire
spray
continuous fire protection
explosion protection
explosion protection continuous fire proof
three-way device
three-way cock
three-way conical cock
three-way ball cock
three-way valve
thrush plate
pressure reducing valve
pressure reducing valve with injection
angle pattern pressure reducing valve with injection
flow limiter with pressure recovery
flame trap explosion proof
flame trap explosion + continuous fire proof
flange pair

flowing direction ->
flowing direction <-
flowing direction of important substances ->
flowing direction of important substances <-
ascent ->
ascent <-
boundary
clamped flange pair
compensator
compensator (corrugated tube)
condensation discharger
condensation discharger plugged in
condensation discharger flanged
condensation discharger welded
ball joint
clutch
Lyracompensator
angle pattern membrane device
mixing jet
mixing section
level indicating
reduction
winded pipe
back stroke device
angle pattern back stroke device
back stroke flap
back stroke valve
angle pattern back stroke valve
dirt trap
current rectifier
sound absorber
gauge glas
gauge glas with indicator
slide sleeve
tube
sprinkler jet
injector
adjusting drive (auxiliary power=flowing substance)
adjusting drive with electromagnet
adjusting drive with electric motor
adjusting drive with spring
adjusting drive with weight
adjusting drive with hydromot. 1 flow direction
adjusting drive with hydromot. 2 flow directions
adjusting drive with piston
adjusting drive with membrane
adjusting drive with pneum. mot. 1 flow direction
adjusting drive with pneum. mot. 2 flow directions
adjusting drive with float
funnel
joint welded, soldered, glued

joint screwed [
joint screwed]
joint plugged [
joint plugged]
joint to atmosphere
closure
bottom closure plugged in
bottom closure screwed
bottom closure soldered
stop closure screwed
screwed joint with nut [
screwed joint with nut]
four-way device
four-way conical cock
four-way ball cock
four-way valve
water meter

(106 symbols)

Heating

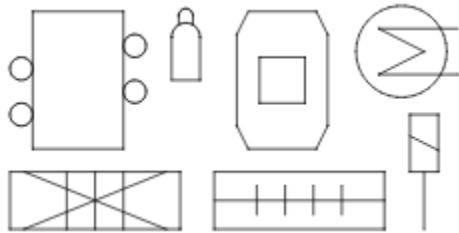

Library Contents

separator
dry separator
settler
stopping device
stop cock
conical stop cock
stopping ball cock
shut-off valve
slide valve
exhaust hood
activated carbon filter
driving engine
axial ventilator
ventilation system device
basin
tank
jacket tank
tank with full-pipe coil
fire protection cap
burner
steam boiler
three-way cock
three-way conical cock
three-way ball cock
three-way valve
pressure reducing valve
electric motor
firing
flowing direction ->
flowing direction <-
liquid ring compressor
gas cylinder
ascent ->
ascent <--
heating
reciprocating pump
reciprocating compressor
industrial furnace

ion exchange filter
chimney
compensator
compensator (corrugated tube)
compressor
condensation discharger
centrifugal pump
cooling tower
cooling
air filter
Lyracompensator
membrane pump
mixing jet
plate heat exchanger
pump
radial ventilator
rake
reduction
shower cooler
gilled tube heat exchanger
gilled tube heat exchanger with ventilator
winded pipe
back stroke device
back stroke valve
sound absorber
tube
dirt trap
chimney
screw compressor
injector
adjusting drive with electromagnet
adjusting drive with electric motor
continuous conveyor
turbine
turbo vacuum pump
vacuum pump
ventilator
compressor
four-way device
four-way conical cock
four-way ball cock
four-way valve
heat exchanger with crossing of flow lines
heat exchanger without crossing of flow lines
gear-type pump

(83 symbols)

Chemistry Laboratory Equipment #1

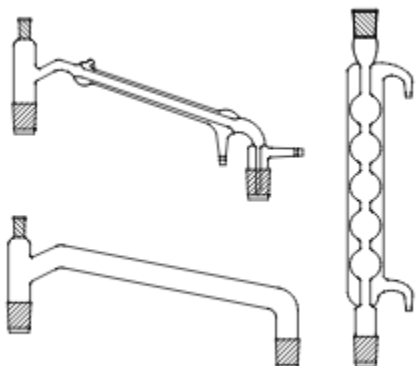

Library Contents

Allihn cooler 300 mm jacket length NS 29/32
Liebig cooler 300 mm jacket length NS 29/32
Dimroth cooler 300 mm jacket length NS 29/32
intensive cooler 300 mm jacket length NS 29/32
coil cooler 300 mm jacket length NS 29/32
Claisen still-head with Liebig cooler H 14/23 K 29/32
still-head with Liebig cooler, suction port, 200 mm jacket
still-head with Liebig cooler 200 mm jacket length NS 29/32
still-head 350 mm NS 29/32
still-head with polished socket 14/23 350 mm NS 29/32
Anschütz-Thiele equipment 50 ml
Anschütz-Thiele equipment 50 ml
Bredt equipment 4 flasks 100 ml
adapter H 14/23 K 29/32
adapter H 29/32 K 14/23
adapter H 29/32 K 45/40
adapter H 45/40 K 29/32

(17 symbols)

Chemistry Laboratory Equipment #2

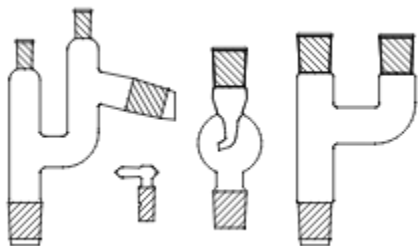

Library Contents

NS 14/23 thimble
NS 14 two-sided tap
NS 14 one-sided tap
NS 14 stopper
NS 14/23 cone
NS 29/32 thimble
NS 29/32 cone
NS 29/32 cone
NS 29/32 cone
distillation thermometer with polished adapter NS 14/23
kjeldahl connecting bulb
Claisen distillation head, lateral grinding 75° K 29/32 H 1
distillation head with inclined grinding 75° K 29/32
two-neck head with parallel sockets NS 29/32
two-neck head with lateral socket 75° NS 29/32
two-neck head with lateral cone 75° NS 29/32
three-neck head NS 29/32
bend 75° socket 29/32
bend 90° socket 29/32
receiver adapter, curved 105°
vacuum receiver adapter
vacuum receiver adapter, curved 105°
Hempel column, filling level 300 mm
Vigreux column, efficient length 300 mm NS 29/32
Widmer column, spiral length 160 mm NS 29/32

(25 symbols)

Chemistry Laboratory Equipment #3

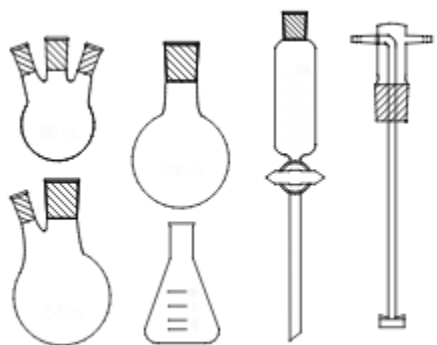

Library Contents

NS 12/21 thimble
NS 12/21 cone
NS 14/23 thimble
NS 14/23 cone
NS 19/26 thimble
NS 19/26 cone
NS 29/32 thimble
NS 29/32 cone
NS 45/40 thimble
NS 45/40 cone
cork ring for 10 - 100 ml
cork ring for 250 - 500 ml
cork ring for 500 - 1000 ml
stopper NS 12/21
stopper NS 29/32
iodine flask 100 ml NS 29/32
iodine flask 250 ml NS 29/32
iodine flask 500 ml NS 29/32
Erlenmeyer flask narrow-mouth 100 ml
Erlenmeyer flask wide-mouth 100 ml
Erlenmeyer flask narrow-mouth 250 ml
Erlenmeyer flask wide-mouth 250 ml
Erlenmeyer flask narrow-mouth 500 ml
Erlenmeyer flask wide-mouth 500 ml
round-bottom flask 50 ml NS 14/23
round-bottom flask 50 ml NS 29/32
round-bottom flask 100 ml NS 14/23
round-bottom flask 100 ml NS 29/32
round-bottom flask 250 ml NS 29/32
round-bottom flask 250 ml NS 45/40
round-bottom flask 500 ml NS 29/32
round-bottom flask 500 ml NS 45/40
flat-bottom flask narrow-mouth 100 ml
flat-bottom flask wide-mouth 100 ml

flat-bottom flask narrow-mouth 250 ml
flat-bottom flask wide-mouth 250 ml
flat-bottom flask narrow-mouth 500 ml
flat-bottom flask wide-mouth 500 ml
flat-bottom flask narrow-mouth 1000 ml
flat-bottom flask wide-mouth 1000 ml
two-neck flask 50 ml 14/23 14/23
two-neck flask 50 ml 29/32 14/23
two-neck flask 100 ml 29/32 14/23
two-neck flask 500 ml 29/32 14/23
two-neck flask 250 ml 29/32 14/23
three-neck flask 100 ml 29/32 14/23 14/23
three-neck flask 250 ml 29/32 14/23 14/23
three-neck flask 500 ml 29/32 14/23 14/23
polished-joint cover, flange 138 mm, NW 100 mm
polished-joint cover, flange 138 mm
polished-joint reaction vessel 500 ml, flange 138 mm, NW 100 mm
polished-joint reaction vessel 1000 ml, flange 138 mm, NW 100 m
polished-joint reaction vessel 2000 ml, flange 138 mm, NW 100 m
polished-joint round-bottom flask 2000 ml, flange 138 mm, NW 10
seperatory funnel 250 ml, scaled
gas-washing bottle NS 29/32
washing bottle insert without diffuser NS 29/32
washing bottle insert with diffuser NS 29/32

(58 symbols)

Furniture #1

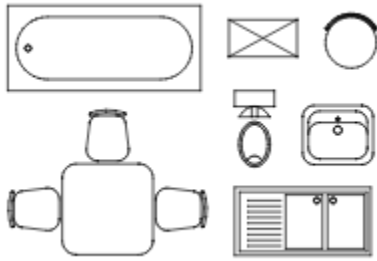

Library Contents

bath tub 1700 * 750

shower tray 900 * 900

electric cooker

dining table 80 * 80

dining table 80 * 80 with 3 chairs (2)

dining table 80 * 80 with 4 chairs (2)

dining table 130 * 80

dining table 130 * 80 with 4 chairs (2)

dining table 130 * 80 with 6 chairs (2)

dining table 180 * 80

dining table 180 * 80 with 4 chairs (2)

dining table 180 * 80 with 4 chairs (2)

dining table 180 * 80 with 6 chairs (2)

dining table 180 * 80 with 8 chairs (2)

dining table oval 130 * 80

dining table oval 130 * 80 with 4 chairs (3)

dining table oval 130 * 80 with 5 chairs (3)

dining table oval 130 * 80 with 6 chairs (3)

dining table oval 180 * 80

dining table oval 180 * 80 with 4 chairs (3)

dining table oval 180 * 80 with 6 chairs (3)

dining table oval 180 * 80 with 8 chairs (3)

dining table round d = 80

dining table round d = 80 with 2 chairs (3)

dining table round d = 80 with 3 chairs (3)

dining table round d = 80 with 4 chairs (3)

dining table round d =120

dining table round d =120 with 4 chairs (3)

dining table round d =120 with 5 chairs (3)

dining table round d =120 with 6 chairs (3)

dining table round d =120 with 9 chairs (3)

wash-basin 620 * 520

hot water tank

high cupboard 45 * 60

high cupboard 50 * 60

high cupboard 60 * 60

high cupboard 80 * 60
kitchen table 80 * 80
kitchen table 80 * 80 with 2 chairs (1)
kitchen table 80 * 80 with 3 chairs (1)
kitchen table 80 * 80 with 4 chairs (1)
kitchen table 130 * 80
kitchen table 130 * 80 with 3 chairs (1)
kitchen table 130 * 80 with 4 chairs (1)
kitchen table 130 * 80 with 5 chairs (1)
kitchen table 130 * 80 with 6 chairs (1)
kitchen table 180 * 80
upper cupboard 45 * 32,5
upper cupboard 50 * 32,5
upper cupboard 60 * 32,5
upper cupboard corner 60 * 60
left basin 80 * 60
right basin 80 * 60
left basin 100 * 60
right basin 100 * 60
left basin 2 120 * 60
right basin 2 120 * 60
chair 1
chair 2
chair 3
lower cupboard 45 * 60
lower cupboard 50 * 60
lower cupboard 60 * 60
lower cupboard 80 * 60
lower cupboard 100 * 60
lower cupboard 105 * 60
lower cupboard 120 * 60
lower cupboard corner 85 * 85
lower cupboard corner 105 * 105
wc
wc with cistern

(71 symbols)

Furniture #2

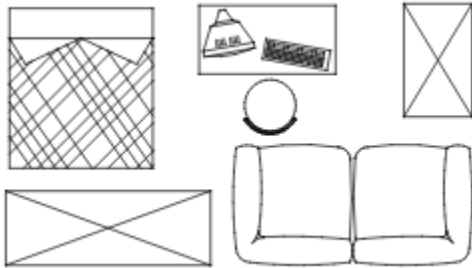

Library Contents

bed 90 * 200
bed 90 * 200 model 1
bed 90 * 200 model 2
bed 90 * 200 model 3
bed 100 * 200
bed 100 * 200 model 1
bed 100 * 200 model 2
bed 100 * 200 model 3
bed 180 * 200
bed 180 * 200 model 1
bed 180 * 200 model 2
bed 180 * 200 model 3
bed 200 * 200
bed 200 * 200 model 1
bed 200 * 200 model 2
bed 200 * 200 model 3
computer monitor 45 * 40
computer keyboard
couch 2-seater
couch 3-seater
coffee table (1) 80 * 80
coffee table (2) 80 * 80
coffee table (1) 120 * 80
coffee table (2) 120 * 80
coffee table 6-cornered 65 * 90
TV 45 * 40 (PORTI)
TV 60 * 47,5
TV 80 * 45
TV armchair
french bed 140 * 200
french bed 140 * 200 model 1
french bed 140 * 200 model 2
french bed 140 * 200 model 3
chest of drawers 110 * 55
speaker 30 * 30
speaker 45 * 35

bedside table 50 * 73,5
bedside table 50 * 50
cupboard 110 * 65
cupboard 150 * 65
cupboard 180 * 65
cupboard 200 * 65
cupboard 220 * 65
cupboard 300 * 65
unit of a cupboard 40 * 38 (cabinet)
unit of a cupboard 40 * 41
unit of a cupboard 40 * 60
unit of a cupboard 80 * 41
unit of a cupboard 80 * 45 (cabinet)
unit of a cupboard 80 * 60
unit of a cupboard 99 * 60
unit of a cupboard 129 * 60
unit of a cupboard high 40 * 38 (cabinet)
unit of a cupboard high 40 * 41
unit of a cupboard high 40 * 60
unit of a cupboard high 80 * 41
unit of a cupboard high 80 * 45 (cabinet)
unit of a cupboard high 80 * 60
unit of a cupboard high 99 * 60
unit of a cupboard high 129 * 60
unit of a cupboard high 1120 * 1120 (corner)
desk 140 * 80
desk 150 * 80
desk 160 * 80
desk 160 * 80 monitor, keyboard
desk 180 * 80
desk 180 * 80 monitor, keyboard
desk for pupils 100 * 50 with chair
desk for pupils 120 * 50 with chair
armchair
unit of a seating section, corner
unit of a seating section, middle
unit of a seating section, round, outside, big
unit of a seating section, round, outside, small
seating section 2-seater
seating section 3-seater
seating section 4-seater
seating section 5-seater, around corner, outside
seating section 7-seater, around corner, inside
seating section round, outside
stereo system 35 * 30
stereo system 45 * 30

(82 symbols)

Hydraulics & Pneumatics

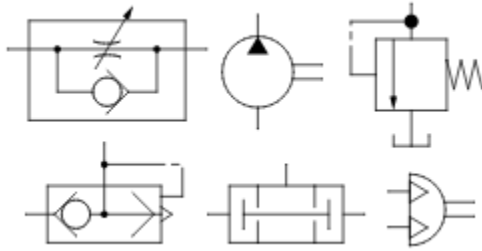

Library Contents

- 1 flow path
- 1 flow path (diag), 1 blocked joint
- 1 flow path (par), 1 blocked joint
- 1 flow path, shunt, 2 blocked joints
- 2 flow paths (par)
- 2 flow paths (par, conn)
- 2 flow paths + 1 blocked joint
- 2 flow paths (X)
- 2 blocked joints
- 3 blocked joints
- 4 blocked joints
- 5 blocked joints
- 6 blocked joints
- tank
- manual operation
- manual operation, push-button
- lever operation
- mechanical operation, spring
- mechanical operation, roll
- mechanical operation, roll, only operating in one direction
- mechanical operation, feeler
- pedal operation
- electromagnet operation
- electromagnet operation and (hy) pilot valve
- electromagnet operation and (pn) pilot valve
- operation (hy) pilot valve
- operation (pn) pilot valve
- direction of rotation bi-direktional
- direction of rotation uni-direktional
- backstrike throttle valve
- throttle valve, non-adjustable
- throttle valve, adjustable
- pressure stop valve
- pressure tank
- compressed-air stream
- pressure source
- pressure regulating valve, relief opening

electric motor
ventilation with connection
ventilation without connection
filter
sequence valve
silencer
hyd.-tank
hyd.-stream
compressor, constant displacement volume
constant motor, 1 conveying direction (hy)
constant motor, 1 conveying direction (pn)
constant pump, 1 stream direction
air dryer
motor
lubricator
pump
spring-loaded backstrike valve
unloaded backstrike valve
quick-ventilation valve
oscillating motor (hy)
oscillating motor (pn)
sieve
stream regulating valve, relief opening, variable orig. stream
stream regulating valve, variable original stream
flow direction bi-directional
flow direction uni-directional 1
flow direction uni-directional 2
adjustability (31° short)
adjustability (31° long)
adjustability (45°)
adjusting pump, 2 conveying directions
water separator
reversing valve
two-pressure valve
cylinder, double operating, one-sided piston rod
cylinder, double operating, final position damping adjustable
cylinder, single operating, reset by spring

(74 symbols)

Environment & Ecology



Library Contents

nuclear power station
big car
small car
farm
mountains
mine, out of operation
operating mine
drilling rig
drilling platform
derrick
chemical factory, out of operation
operating chemical factory
oil refinery
factory, out of operation
operating factory
barrel
fish
house
blast-furnace
high tension pylon
church
village
coal power station
cooling tower
deciduous tree
human being
conifer
conifer 10 - 19% destroyed
conifer 20 - 39% destroyed
conifer 40 - 59% destroyed
conifer 60 - 79% destroyed
conifer 80 - 100% destroyed
smoke
radioactivity
sack
reed
silo

silo plant
stream
rotating stream
powerful stream
pond
tractor
truck
flying bird
whale
wind turbine
cloud
warm air

(49 symbols)

Landscape Design

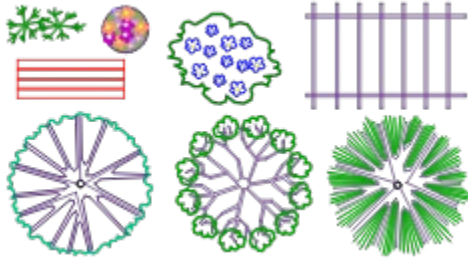

Library Contents

bloom 1 black
bloom 2
bloom 3
bloom 4
meadow as filling pattern
bush 1 black
bush 1
bush 2 black
bush 2
bush 3 black
bush 3
garden grill, round black
garden chair black
garden table, oval black
garden table, round black
green spaces as filling pattern
hedge 1 black
hedge 1
hedge 2 black
hedge 2
hedge 3 black
hedge 3
cascade well
lamp black
deciduous tree
deciduous tree 1 black
deciduous tree 2
deciduous tree 3
deciduous tree 4a black
deciduous tree 4 black
deciduous tree 4
deciduous tree 4a black (connecting piece for rows)
deciduous tree 4 black (connecting piece for rows)
deciduous tree 4 (connecting piece for rows)
deciduous tree 4a black (row of trees)
deciduous tree 4 black (row of trees)

deciduous tree 4 (row of trees)
deciduous tree 5
deciduous tree 6 black
deciduous tree 7 black
deciduous tree 7
deciduous tree 8
millstone well
conifer
conifer 1
conifer 1 (connecting piece for rows)
conifer 2 black
conifer 2
conifer 3
coniferuos spinney 1 black
coniferuos spinney 1
coniferuos spinney 2 black
coniferuos spinney 2
coniferuos spinney 3
coniferuos spinney 4
natural stone as filling pattern
natural stone 2 as filling pattern
north arrow
paper bin
park bench
bower
tub for plants, round black
tub for plants, round
tub for plants, round
tub for plants, hexagonal round
tub for plants, hexagonal
tub for plants, hexagonal
sand as filling pattern
sand pit
hexagon stone as filling pattern
waterlilies
sunshade
sunshade
plaything with slide and climbing frame
covered plaything with slide and climbing frame
herbaceous plant 1
herbaceous plant 2
herbaceous plant 3
herbaceous plant 4
herbaceous plant 5
herbaceous plant 6 black
herbaceous plant 7
herbaceous plant 8
herbaceous plant 9
herbaceous plant 10
stones
rock plants

pond
pond with waterlilies
compound stone as filling pattern

(90 symbols)

Electrical Engineering #2

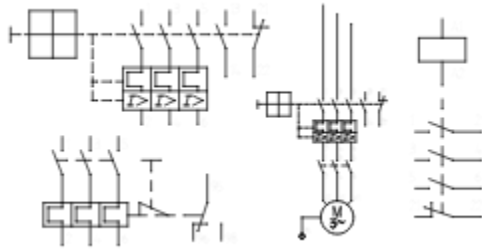

Library Contents

3 phase vertical 100mm long
3 phase horizontal 100mm long
Dahlander 1 direction of rotation, 2 speeds
Dahlander 2 directions of rotation, 2 speeds
Dahlander star-delta, 1 direction of rotation
master contactor + 13,14
master contactor + 21,22
auxiliary contactor 22
auxiliary contactor 31
auxiliary contactor 40
auxiliary switch module 02
auxiliary switch module 04
auxiliary switch module 11
auxiliary switch module 11, address delayed
auxiliary switch module 11, relapse delayed
auxiliary switch module 13
auxiliary switch module 20
auxiliary switch module 22
auxiliary switch module 40
motor 3 ph with Q and contactor
motor 3 ph star-delta starting
motor 3 ph star-delta starting rotating r-l
motor 3 ph rotating r-l with m-protection relay
motor 3 ph rotating r-l with Q
motor-protection relay with 97/98 , 95/96; main contacts
motor-protection relay with 95/98 96; main contacts
motor-protection circuit breaker; 13/14; main contacts
motor-protection circuit breaker; 21/22; main contacts
motor-protection circuit breaker; 13/14, 21/22; main contacts
Q as primary protection of a control transformer
Q as primary + secondary protection of a control transformer
contactor coil A1/A2
contactor coil E1/E2
spark quenching diode
spark quenching RC-section
spark quenching varistor

reversing contactor; motor-protection circuit breaker; 13/14, 2

(37 symbols)

Steel Sections

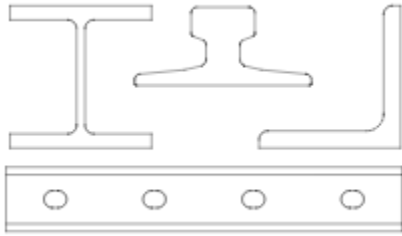

Library Contents

- 001: I PB 100
- 002: I PB 100
- 003: I PB 120
- 004: I PB 120
- 005: I PB 140
- 006: I PB 140
- 007: crane track A 45
- 008: crane track A 45
- 009: crane track A 55
- 010: crane track A 55
- 011: crane track A 65
- 012: crane track A 65
- 013: crane track A 75
- 014: crane track A 75
- 015: crane track A 100
- 016: crane track A 100
- 017: crane track A 120
- 018: crane track A 120
- 019: crane track F 100
- 020: crane track F 100
- 021: crane track F 120
- 022: crane track F 120
- 023: L 20 * 3
- 024: L 20 * 3
- 025: L 25 * 3
- 026: L 25 * 3
- 027: L 25 * 4
- 028: L 25 * 4
- 029: L 30 * 3
- 030: L 30 * 3
- 031: L 30 * 4
- 032: L 30 * 4
- 033: L 35 * 4
- 034: L 35 * 4
- 035: L 35 * 5
- 036: L 35 * 5
- 037: L 40 * 4

038: L 40 * 4
039: L 40 * 5
040: L 40 * 5
041: L 45 * 5
042: L 45 * 5
043: L 50 * 5
044: L 50 * 5
045: L 50 * 6
046: L 50 * 6
047: L 50 * 7
048: L 50 * 7
049: L 60 * 5
050: L 60 * 5
051: L 60 * 6
052: L 60 * 6
053: L 60 * 8
054: L 60 * 8
055: L 65 * 7
056: L 65 * 7
057: L 70 * 7
058: L 70 * 7
059: L 70 * 9
060: L 70 * 9
061: L 75 * 7
062: L 75 * 7
063: L 75 * 8
064: L 75 * 8
065: L 80 * 6
066: L 80 * 6
067: L 80 * 8
068: L 80 * 8
069: L 80 * 10
070: L 80 * 10
071: L 90 * 7
072: L 90 * 7
073: L 90 * 9
074: L 90 * 9
075: L 100 * 8
076: L 100 * 8
077: L 100 * 10
078: L 100 * 10
079: L 100 * 12
080: L 100 * 12
081: L 30 * 20 * 3
082: L 30 * 20 * 3
083: L 30 * 20 * 3
084: L 30 * 20 * 4
085: L 30 * 20 * 4
086: L 30 * 20 * 4
087: L 40 * 20 * 3
088: L 40 * 20 * 3

089: L 40 * 20 * 3
090: L 40 * 20 * 4
091: L 40 * 20 * 4
092: L 40 * 20 * 4
093: L 45 * 30 * 4
094: L 45 * 30 * 4
095: L 45 * 30 * 4
096: L 45 * 30 * 5
097: L 45 * 30 * 5
098: L 45 * 30 * 5
099: L 50 * 30 * 4
100: L 50 * 30 * 4
101: L 50 * 30 * 4
102: L 50 * 30 * 5
103: L 50 * 30 * 5
104: L 50 * 30 * 5
105: L 50 * 40 * 5
106: L 50 * 40 * 5
107: L 50 * 40 * 5
108: L 60 * 30 * 5
109: L 60 * 30 * 5
110: L 60 * 30 * 5
111: L 60 * 40 * 5
112: L 60 * 40 * 5
113: L 60 * 40 * 5
114: L 60 * 40 * 6
115: L 60 * 40 * 6
116: L 60 * 40 * 6
117: L 65 * 50 * 5
118: L 65 * 50 * 5
119: L 65 * 50 * 5
120: L 70 * 50 * 6
121: L 70 * 50 * 6
122: L 70 * 50 * 6
123: L 75 * 50 * 7
124: L 75 * 50 * 7
125: L 75 * 50 * 7
126: L 75 * 55 * 5
127: L 75 * 55 * 5
128: L 75 * 55 * 5
129: L 75 * 55 * 7
130: L 75 * 55 * 7
131: L 75 * 55 * 7
132: L 80 * 40 * 6
133: L 80 * 40 * 6
134: L 80 * 40 * 6
135: L 80 * 40 * 8
136: L 80 * 40 * 8
137: L 80 * 40 * 8
138: L 80 * 60 * 7
139: L 80 * 60 * 7

140: L 80 * 60 * 7
141: L 90 * 60 * 6
142: L 90 * 60 * 6
143: L 90 * 60 * 6
144: L 90 * 60 * 8
145: L 90 * 60 * 8
146: L 90 * 60 * 8
147: L 100 * 50 * 6
148: L 100 * 50 * 6
149: L 100 * 50 * 6
150: L 100 * 50 * 8
151: L 100 * 50 * 8
152: L 100 * 50 * 8
153: L 100 * 50 * 10
154: L 100 * 50 * 10
155: L 100 * 50 * 10
156: track S 7
157: track S 7
158: track S 7 strap FL 7
159: track S 7 strap FL 7
160: track S 10
161: track S 10
162: track S 10 strap FL 10
163: track S 10 strap FL 10
164: U 30 * 15
165: U 30 * 15
166: U 30
167: U 30
168: U 40 * 20
169: U 40 * 20
170: U 40
171: U 40
172: U 50 * 25
173: U 50 * 25
174: U 50
175: U 50
176: U 60
177: U 60
178: U 65
179: U 65
180: U 80
181: U 80
182: U 100
183: U 100
184: U 120
185: U 120
186: U 140
187: U 140
188: U 160
189: U 160
190: U 180

191: U 180
192: U 200
193: U 200
194: U 220
195: U 220
196: U 240
197: U 240
198: U 260
199: U 260
200: U 280
201: U 280
202: U 300
203: U 300
204: U 320
205: U 320
206: U 350
207: U 350
208: U 380
209: U 380
210: U 400
211: U 400
212: Z 30
213: Z 30
214: Z 40
215: Z 40
216: Z 50
217: Z 50
218: Z 60
219: Z 60
220: Z 80
221: Z 80
222: Z 100
223: Z 100
224: Z 120
225: Z 120
226: Z 140
227: Z 140
228: Z 160
229: Z 160

(229 symbols)

Screws DIN 912

For TommySoftware® CAD/DRAW 3 and CAD/DRAW 4 only!!!

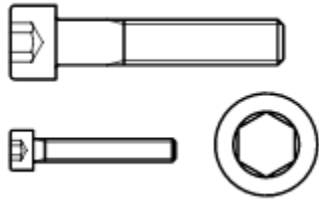

Library Contents

Normal View\M 1.4\2 lg
Normal View\M 1.4\2.5lg
Normal View\M 1.4\3 lg
Normal View\M 1.4\4 lg
Normal View\M 1.4\5 lg
Normal View\M 1.4\6 lg
Normal View\M 1.4\8 lg
Normal View\M 1.4\10 lg
Normal View\M 1.4\12 lg
Normal View\M 1.6\2.5lg
Normal View\M 1.6\3 lg
Normal View\M 1.6\4 lg
Normal View\M 1.6\5 lg
Normal View\M 1.6\6 lg
Normal View\M 1.6\8 lg
Normal View\M 1.6\10 lg
Normal View\M 1.6\12 lg
Normal View\M 1.6\16 lg
Normal View\M 2\3 lg
Normal View\M 2\4 lg
Normal View\M 2\5 lg
Normal View\M 2\6 lg
Normal View\M 2\8 lg
Normal View\M 2\10 lg
Normal View\M 2\12 lg
Normal View\M 2\16 lg
Normal View\M 2\20 lg
Normal View\M 3\5 lg
Normal View\M 3\6 lg
Normal View\M 3\8 lg
Normal View\M 3\10 lg
Normal View\M 3\12 lg
Normal View\M 3\16 lg
Normal View\M 3\20 lg
Normal View\M 3\25 lg
Normal View\M 3\30 lg
Normal View\M 2.5\4 lg

Normal View\M 2.5\5 lg
Normal View\M 2.5\6 lg
Normal View\M 2.5\8 lg
Normal View\M 2.5\10 lg
Normal View\M 2.5\12 lg
Normal View\M 2.5\16 lg
Normal View\M 2.5\20 lg
Normal View\M 2.5\25 lg
Normal View\M 4\6 lg
Normal View\M 4\8 lg
Normal View\M 4\10 lg
Normal View\M 4\12 lg
Normal View\M 4\16 lg
Normal View\M 4\20 lg
Normal View\M 4\25 lg
Normal View\M 4\30 lg
Normal View\M 4\35 lg
Normal View\M 4\40 lg
Normal View\M 5\8 lg
Normal View\M 5\10 lg
Normal View\M 5\12 lg
Normal View\M 5\16 lg
Normal View\M 5\20 lg
Normal View\M 5\25 lg
Normal View\M 5\30 lg
Normal View\M 5\35 lg
Normal View\M 5\40 lg
Normal View\M 5\45 lg
Normal View\M 5\50 lg
Normal View\M 6\10 lg
Normal View\M 6\12 lg
Normal View\M 6\16 lg
Normal View\M 6\20 lg
Normal View\M 6\25 lg
Normal View\M 6\30 lg
Normal View\M 6\35 lg
Normal View\M 6\40 lg
Normal View\M 6\45 lg
Normal View\M 6\50 lg
Normal View\M 6\55 lg
Normal View\M 6\60 lg
Normal View\M 8\12 lg
Normal View\M 8\16 lg
Normal View\M 8\20 lg
Normal View\M 8\25 lg
Normal View\M 8\30 lg
Normal View\M 8\35 lg
Normal View\M 8\40 lg
Normal View\M 8\45 lg
Normal View\M 8\50 lg
Normal View\M 8\55 lg

Normal View\M 8\60 lg
Normal View\M 8\65 lg
Normal View\M 8\70 lg
Normal View\M 8\80 lg
Normal View\M 10\16 lg
Normal View\M 10\20 lg
Normal View\M 10\25 lg
Normal View\M 10\30 lg
Normal View\M 10\35 lg
Normal View\M 10\40 lg
Normal View\M 10\45 lg
Normal View\M 10\50 lg
Normal View\M 10\55 lg
Normal View\M 10\60 lg
Normal View\M 10\65 lg
Normal View\M 10\70 lg
Normal View\M 10\80 lg
Normal View\M 10\90 lg
Normal View\M 10\100 lg
Normal View\M 12\20 lg
Normal View\M 12\25 lg
Normal View\M 12\30 lg
Normal View\M 12\35 lg
Normal View\M 12\40 lg
Normal View\M 12\45 lg
Normal View\M 12\50 lg
Normal View\M 12\55 lg
Normal View\M 12\60 lg
Normal View\M 12\65 lg
Normal View\M 12\70 lg
Normal View\M 12\80 lg
Normal View\M 12\90 lg
Normal View\M 12\100 lg
Normal View\M 12\110 lg
Normal View\M 12\120 lg
Normal View\M 16\25 lg
Normal View\M 16\30 lg
Normal View\M 16\35 lg
Normal View\M 16\40 lg
Normal View\M 16\45 lg
Normal View\M 16\50 lg
Normal View\M 16\55 lg
Normal View\M 16\60 lg
Normal View\M 16\65 lg
Normal View\M 16\70 lg
Normal View\M 16\80 lg
Normal View\M 16\90 lg
Normal View\M 16\100 lg
Normal View\M 16\110 lg
Normal View\M 16\120 lg
Normal View\M 16\130 lg

Normal View\M 16\140 lg
Normal View\M 16\150 lg
Normal View\M 16\160 lg
Normal View\M 20\30 lg
Normal View\M 20\35 lg
Normal View\M 20\40 lg
Normal View\M 20\45 lg
Normal View\M 20\50 lg
Normal View\M 20\55 lg
Normal View\M 20\60 lg
Normal View\M 20\65 lg
Normal View\M 20\70 lg
Normal View\M 20\80 lg
Normal View\M 20\90 lg
Normal View\M 20\100 lg
Normal View\M 20\110 lg
Normal View\M 20\120 lg
Normal View\M 20\130 lg
Normal View\M 20\140 lg
Normal View\M 20\150 lg
Normal View\M 20\160 lg
Normal View\M 20\180 lg
Normal View\M 20\200 lg
Normal View\M 24\40 lg
Normal View\M 24\45 lg
Normal View\M 24\50 lg
Normal View\M 24\55 lg
Normal View\M 24\60 lg
Normal View\M 24\65 lg
Normal View\M 24\70 lg
Normal View\M 24\80 lg
Normal View\M 24\90 lg
Normal View\M 24\100 lg
Normal View\M 24\110 lg
Normal View\M 24\120 lg
Normal View\M 24\130 lg
Normal View\M 24\140 lg
Normal View\M 24\150 lg
Normal View\M 24\160 lg
Normal View\M 24\180 lg
Normal View\M 24\200 lg
Normal View\M 30\45 lg
Normal View\M 30\50 lg
Normal View\M 30\55 lg
Normal View\M 30\60 lg
Normal View\M 30\65 lg
Normal View\M 30\70 lg
Normal View\M 30\80 lg
Normal View\M 30\90 lg
Normal View\M 30\100 lg
Normal View\M 30\110 lg

Normal View\M 30\120 lg
Normal View\M 30\130 lg
Normal View\M 30\140 lg
Normal View\M 30\150 lg
Normal View\M 30\160 lg
Normal View\M 30\180 lg
Normal View\M 30\200 lg
Normal View\M 36\55 lg
Normal View\M 36\60 lg
Normal View\M 36\65 lg
Normal View\M 36\70 lg
Normal View\M 36\80 lg
Normal View\M 36\90 lg
Normal View\M 36\100 lg
Normal View\M 36\110 lg
Normal View\M 36\120 lg
Normal View\M 36\130 lg
Normal View\M 36\140 lg
Normal View\M 36\150 lg
Normal View\M 36\160 lg
Normal View\M 36\180 lg
Normal View\M 36\200 lg
Normal View\M 36\220 lg
Normal View\M 36\240 lg
Normal View\M 36\260 lg
Normal View\M 36\280 lg
Normal View\M 36\300 lg
Normal View\M 42\60 lg
Normal View\M 42\65 lg
Normal View\M 42\70 lg
Normal View\M 42\80 lg
Normal View\M 42\90 lg
Normal View\M 42\100 lg
Normal View\M 42\110 lg
Normal View\M 42\120 lg
Normal View\M 42\130 lg
Normal View\M 42\140 lg
Normal View\M 42\150 lg
Normal View\M 42\160 lg
Normal View\M 42\180 lg
Normal View\M 42\200 lg
Normal View\M 42\220 lg
Normal View\M 42\240 lg
Normal View\M 42\260 lg
Normal View\M 42\280 lg
Normal View\M 42\300 lg
Normal View\M 48\70 lg
Normal View\M 48\80 lg
Normal View\M 48\90 lg
Normal View\M 48\100 lg
Normal View\M 48\110 lg

Normal View\M 48\120 lg
Normal View\M 48\130 lg
Normal View\M 48\140 lg
Normal View\M 48\150 lg
Normal View\M 48\160 lg
Normal View\M 48\180 lg
Normal View\M 48\200 lg
Normal View\M 48\220 lg
Normal View\M 48\240 lg
Normal View\M 48\260 lg
Normal View\M 48\280 lg
Normal View\M 48\300 lg
Normal View\M 56\80 lg
Normal View\M 56\90 lg
Normal View\M 56\100 lg
Normal View\M 56\110 lg
Normal View\M 56\120 lg
Normal View\M 56\130 lg
Normal View\M 56\140 lg
Normal View\M 56\150 lg
Normal View\M 56\160 lg
Normal View\M 56\180 lg
Normal View\M 56\200 lg
Normal View\M 56\220 lg
Normal View\M 56\240 lg
Normal View\M 56\260 lg
Normal View\M 56\280 lg
Normal View\M 56\300 lg
Normal View\M 64\90 lg
Normal View\M 64\100 lg
Normal View\M 64\110 lg
Normal View\M 64\120 lg
Normal View\M 64\130 lg
Normal View\M 64\140 lg
Normal View\M 64\150 lg
Normal View\M 64\160 lg
Normal View\M 64\180 lg
Normal View\M 64\200 lg
Normal View\M 64\220 lg
Normal View\M 64\240 lg
Normal View\M 64\260 lg
Normal View\M 64\280 lg
Normal View\M 64\300 lg
Normal View\M 72\100 lg
Normal View\M 72\110 lg
Normal View\M 72\120 lg
Normal View\M 72\130 lg
Normal View\M 72\140 lg
Normal View\M 72\150 lg
Normal View\M 72\160 lg
Normal View\M 72\180 lg

Normal View\M 72\200 lg
Normal View\M 72\220 lg
Normal View\M 72\240 lg
Normal View\M 72\260 lg
Normal View\M 72\280 lg
Normal View\M 72\300 lg
Normal View\M 80\120 lg
Normal View\M 80\130 lg
Normal View\M 80\140 lg
Normal View\M 80\150 lg
Normal View\M 80\160 lg
Normal View\M 80\180 lg
Normal View\M 80\200 lg
Normal View\M 80\220 lg
Normal View\M 80\240 lg
Normal View\M 80\260 lg
Normal View\M 80\280 lg
Normal View\M 80\300 lg
Normal View\M 90\140 lg
Normal View\M 90\150 lg
Normal View\M 90\160 lg
Normal View\M 90\180 lg
Normal View\M 90\200 lg
Normal View\M 90\220 lg
Normal View\M 90\240 lg
Normal View\M 90\260 lg
Normal View\M 90\280 lg
Normal View\M 90\300 lg
Normal View\M 100\150 lg
Normal View\M 100\160 lg
Normal View\M 100\180 lg
Normal View\M 100\200 lg
Normal View\M 100\220 lg
Normal View\M 100\240 lg
Normal View\M 100\260 lg
Normal View\M 100\280 lg
Normal View\M 100\300 lg
Side View\M 1.4
Side View\M 1.6
Side View\M 2
Side View\M 2.5
Side View\M 3
Side View\M 4
Side View\M 5
Side View\M 6
Side View\M 8
Side View\M 10
Side View\M 12
Side View\M 16
Side View\M 20
Side View\M 24

Side View\M 30
Side View\M 36
Side View\M 42
Side View\M 48
Side View\M 56
Side View\M 64
Side View\M 72
Side View\M 80
Side View\M 90
Side View\M 100

(353 symbols)

Screws DIN 931

For TommySoftware® CAD/DRAW 3 and CAD/DRAW 4 only!!!

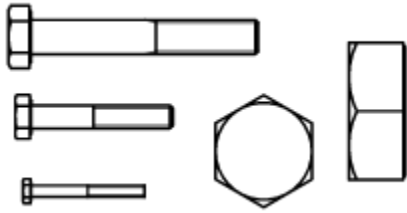

Library Contents

Normal View\M 1.6\12 lg
Normal View\M 1.6\16 lg
Normal View\M 2\16 lg
Normal View\M 2\20 lg
Normal View\M 2.5\16 lg
Normal View\M 2.5\20 lg
Normal View\M 2.5\25 lg
Normal View\M 3\20 lg
Normal View\M 3\25 lg
Normal View\M 3\30 lg
Normal View\M 4\25 lg
Normal View\M 4\30 lg
Normal View\M 4\35 lg
Normal View\M 4\40 lg
Normal View\M 5\25 lg
Normal View\M 5\30 lg
Normal View\M 5\35 lg
Normal View\M 5\40 lg
Normal View\M 5\45 lg
Normal View\M 5\50 lg
Normal View\M 6\30 lg
Normal View\M 6\35 lg
Normal View\M 6\40 lg
Normal View\M 6\45 lg
Normal View\M 6\50 lg
Normal View\M 6\55 lg
Normal View\M 6\60 lg
Normal View\M 8\35 lg
Normal View\M 8\40 lg
Normal View\M 8\45 lg
Normal View\M 8\50 lg
Normal View\M 8\55 lg
Normal View\M 8\60 lg
Normal View\M 8\65 lg
Normal View\M 8\70 lg
Normal View\M 8\80 lg
Normal View\M 10\40 lg

Normal View\M 10\45 lg
Normal View\M 10\50 lg
Normal View\M 10\55 lg
Normal View\M 10\60 lg
Normal View\M 10\65 lg
Normal View\M 10\70 lg
Normal View\M 10\80 lg
Normal View\M 10\90 lg
Normal View\M 10\100 lg
Normal View\M 12\45 lg
Normal View\M 12\50 lg
Normal View\M 12\55 lg
Normal View\M 12\60 lg
Normal View\M 12\65 lg
Normal View\M 12\70 lg
Normal View\M 12\80 lg
Normal View\M 12\90 lg
Normal View\M 12\100 lg
Normal View\M 12\110 lg
Normal View\M 12\120 lg
Normal View\M 16\55 lg
Normal View\M 16\60 lg
Normal View\M 16\65 lg
Normal View\M 16\70 lg
Normal View\M 16\80 lg
Normal View\M 16\90 lg
Normal View\M 16\100 lg
Normal View\M 16\110 lg
Normal View\M 16\120 lg
Normal View\M 16\130 lg
Normal View\M 16\140 lg
Normal View\M 16\150 lg
Normal View\M 16\160 lg
Normal View\M 20\65 lg
Normal View\M 20\70 lg
Normal View\M 20\80 lg
Normal View\M 20\90 lg
Normal View\M 20\100 lg
Normal View\M 20\110 lg
Normal View\M 20\120 lg
Normal View\M 20\130 lg
Normal View\M 20\140 lg
Normal View\M 20\150 lg
Normal View\M 20\160 lg
Normal View\M 20\180 lg
Normal View\M 20\200 lg
Normal View\M 24\70 lg
Normal View\M 24\80 lg
Normal View\M 24\90 lg
Normal View\M 24\100 lg
Normal View\M 24\110 lg

Normal View\M 24\120 lg
Normal View\M 24\130 lg
Normal View\M 24\140 lg
Normal View\M 24\150 lg
Normal View\M 24\160 lg
Normal View\M 24\180 lg
Normal View\M 24\200 lg
Normal View\M 24\220 lg
Normal View\M 24\240 lg
Normal View\M 30\90 lg
Normal View\M 30\100 lg
Normal View\M 30\110 lg
Normal View\M 30\120 lg
Normal View\M 30\130 lg
Normal View\M 30\140 lg
Normal View\M 30\150 lg
Normal View\M 30\160 lg
Normal View\M 30\180 lg
Normal View\M 30\200 lg
Normal View\M 30\220 lg
Normal View\M 30\240 lg
Normal View\M 30\260 lg
Normal View\M 30\280 lg
Normal View\M 30\300 lg
Normal View\M 36\110 lg
Normal View\M 36\120 lg
Normal View\M 36\130 lg
Normal View\M 36\140 lg
Normal View\M 36\150 lg
Normal View\M 36\160 lg
Normal View\M 36\180 lg
Normal View\M 36\200 lg
Normal View\M 36\220 lg
Normal View\M 36\240 lg
Normal View\M 36\260 lg
Normal View\M 36\280 lg
Normal View\M 36\300 lg
Normal View\M 42\130 lg
Normal View\M 42\140 lg
Normal View\M 42\150 lg
Normal View\M 42\160 lg
Normal View\M 42\180 lg
Normal View\M 42\200 lg
Normal View\M 42\220 lg
Normal View\M 42\240 lg
Normal View\M 42\260 lg
Normal View\M 42\280 lg
Normal View\M 42\300 lg
Normal View\M 48\140 lg
Normal View\M 48\150 lg
Normal View\M 48\160 lg

Normal View\M 48\180 lg
Normal View\M 48\200 lg
Normal View\M 48\220 lg
Normal View\M 48\240 lg
Normal View\M 48\260 lg
Normal View\M 48\280 lg
Normal View\M 48\300 lg
Normal View\M 48\320 lg
Normal View\M 48\340 lg
Normal View\M 56\160 lg
Normal View\M 56\180 lg
Normal View\M 56\200 lg
Normal View\M 56\220 lg
Normal View\M 56\240 lg
Normal View\M 56\260 lg
Normal View\M 56\280 lg
Normal View\M 56\300 lg
Normal View\M 56\320 lg
Normal View\M 56\340 lg
Normal View\M 56\360 lg
Normal View\M 64\180 lg
Normal View\M 64\200 lg
Normal View\M 64\220 lg
Normal View\M 64\240 lg
Normal View\M 64\260 lg
Normal View\M 64\280 lg
Normal View\M 64\300 lg
Normal View\M 64\320 lg
Normal View\M 64\340 lg
Normal View\M 64\360 lg
Normal View\M 72\200 lg
Normal View\M 72\220 lg
Normal View\M 72\240 lg
Normal View\M 72\260 lg
Normal View\M 72\280 lg
Normal View\M 72\300 lg
Normal View\M 72\320 lg
Normal View\M 72\340 lg
Normal View\M 72\360 lg
Normal View\M 72\380 lg
Normal View\M 72\400 lg
Normal View\M 80\220 lg
Normal View\M 90\240 lg
Normal View\M 100\260 lg
Normal View\M 110\280 lg
Normal View\M 125\320 lg
Normal View\M 140\340 lg
Normal View\M 160\380 lg
Plan View\M 1.6
Plan View\M 2
Plan View\M 2.5

Plan View\M 3
Plan View\M 4
Plan View\M 5
Plan View\M 6
Plan View\M 8
Plan View\M 10
Plan View\M 12
Plan View\M 16
Plan View\M 20
Plan View\M 24
Plan View\M 30
Plan View\M 36
Plan View\M 42
Plan View\M 48
Plan View\M 56
Plan View\M 64
Plan View\M 72
Plan View\M 80
Plan View\M 90
Plan View\M 100
Plan View\M 110
Plan View\M 125
Plan View\M 140
Plan View\M 160
Side View\M 1.6
Side View\M 2
Side View\M 2.5
Side View\M 3
Side View\M 4
Side View\M 5
Side View\M 6
Side View\M 8
Side View\M 10
Side View\M 12
Side View\M 16
Side View\M 20
Side View\M 24
Side View\M 30
Side View\M 36
Side View\M 42
Side View\M 48
Side View\M 56
Side View\M 64
Side View\M 72
Side View\M 80
Side View\M 90
Side View\M 100
Side View\M 110
Side View\M 125
Side View\M 140
Side View\M 160

(241 symbols)

Screws DIN 933

For TommySoftware® CAD/DRAW 3 and CAD/DRAW 4 only!!!

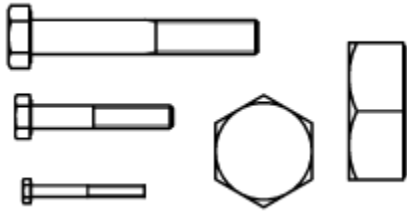

Library Contents

Normal View\M 1.6\2 lg
Normal View\M 1.6\3 lg
Normal View\M 1.6\4 lg
Normal View\M 1.6\5 lg
Normal View\M 1.6\6 lg
Normal View\M 1.6\8 lg
Normal View\M 1.6\10 lg
Normal View\M 1.6\12 lg
Normal View\M 2\3 lg
Normal View\M 2\4 lg
Normal View\M 2\5 lg
Normal View\M 2\6 lg
Normal View\M 2\8 lg
Normal View\M 2\10 lg
Normal View\M 2\12 lg
Normal View\M 2\16 lg
Normal View\M 2.5\3 lg
Normal View\M 2.5\4 lg
Normal View\M 2.5\5 lg
Normal View\M 2.5\6 lg
Normal View\M 2.5\8 lg
Normal View\M 2.5\10 lg
Normal View\M 2.5\12 lg
Normal View\M 2.5\16 lg
Normal View\M 2.5\20 lg
Normal View\M 2.5\25 lg
Normal View\M 3\4 lg
Normal View\M 3\5 lg
Normal View\M 3\6 lg
Normal View\M 3\8 lg
Normal View\M 3\10 lg
Normal View\M 3\12 lg
Normal View\M 3\16 lg
Normal View\M 3\20 lg
Normal View\M 3\25 lg
Normal View\M 3\30 lg
Normal View\M 4\5 lg

Normal View\M 4\6 lg
Normal View\M 4\8 lg
Normal View\M 4\10 lg
Normal View\M 4\12 lg
Normal View\M 4\16 lg
Normal View\M 4\20 lg
Normal View\M 4\25 lg
Normal View\M 4\30 lg
Normal View\M 4\35 lg
Normal View\M 4\40 lg
Normal View\M 4\45 lg
Normal View\M 4\50 lg
Normal View\M 4\55 lg
Normal View\M 4\60 lg
Normal View\M 4\65 lg
Normal View\M 4\70 lg
Normal View\M 5\6 lg
Normal View\M 5\8 lg
Normal View\M 5\10 lg
Normal View\M 5\12 lg
Normal View\M 5\16 lg
Normal View\M 5\20 lg
Normal View\M 5\25 lg
Normal View\M 5\30 lg
Normal View\M 5\35 lg
Normal View\M 5\40 lg
Normal View\M 5\45 lg
Normal View\M 5\50 lg
Normal View\M 5\55 lg
Normal View\M 5\60 lg
Normal View\M 5\65 lg
Normal View\M 5\70 lg
Normal View\M 5\80 lg
Normal View\M 6\6 lg
Normal View\M 6\8 lg
Normal View\M 6\10 lg
Normal View\M 6\12 lg
Normal View\M 6\16 lg
Normal View\M 6\20 lg
Normal View\M 6\25 lg
Normal View\M 6\30 lg
Normal View\M 6\35 lg
Normal View\M 6\40 lg
Normal View\M 6\45 lg
Normal View\M 6\50 lg
Normal View\M 6\55 lg
Normal View\M 6\60 lg
Normal View\M 6\65 lg
Normal View\M 6\70 lg
Normal View\M 6\80 lg
Normal View\M 8\8 lg

Normal View\M 8\10 lg
Normal View\M 8\12 lg
Normal View\M 8\16 lg
Normal View\M 8\20 lg
Normal View\M 8\25 lg
Normal View\M 8\30 lg
Normal View\M 8\35 lg
Normal View\M 8\40 lg
Normal View\M 8\45 lg
Normal View\M 8\50 lg
Normal View\M 8\55 lg
Normal View\M 8\60 lg
Normal View\M 8\65 lg
Normal View\M 8\70 lg
Normal View\M 8\80 lg
Normal View\M 8\90 lg
Normal View\M 8\100 lg
Normal View\M 10\8 lg
Normal View\M 10\10 lg
Normal View\M 10\12 lg
Normal View\M 10\16 lg
Normal View\M 10\20 lg
Normal View\M 10\25 lg
Normal View\M 10\30 lg
Normal View\M 10\35 lg
Normal View\M 10\40 lg
Normal View\M 10\45 lg
Normal View\M 10\50 lg
Normal View\M 10\55 lg
Normal View\M 10\60 lg
Normal View\M 10\65 lg
Normal View\M 10\70 lg
Normal View\M 10\80 lg
Normal View\M 10\90 lg
Normal View\M 10\100 lg
Normal View\M 10\110 lg
Normal View\M 10\120 lg
Normal View\M 10\130 lg
Normal View\M 10\140 lg
Normal View\M 10\150 lg
Normal View\M 12\10 lg
Normal View\M 12\12 lg
Normal View\M 12\16 lg
Normal View\M 12\20 lg
Normal View\M 12\25 lg
Normal View\M 12\30 lg
Normal View\M 12\35 lg
Normal View\M 12\40 lg
Normal View\M 12\45 lg
Normal View\M 12\50 lg
Normal View\M 12\55 lg

Normal View\M 12\60 lg
Normal View\M 12\65 lg
Normal View\M 12\70 lg
Normal View\M 12\80 lg
Normal View\M 12\90 lg
Normal View\M 12\100 lg
Normal View\M 12\110 lg
Normal View\M 12\120 lg
Normal View\M 12\130 lg
Normal View\M 12\140 lg
Normal View\M 12\150 lg
Normal View\M 16\12 lg
Normal View\M 16\16 lg
Normal View\M 16\20 lg
Normal View\M 16\25 lg
Normal View\M 16\30 lg
Normal View\M 16\35 lg
Normal View\M 16\40 lg
Normal View\M 16\45 lg
Normal View\M 16\50 lg
Normal View\M 16\55 lg
Normal View\M 16\60 lg
Normal View\M 16\65 lg
Normal View\M 16\70 lg
Normal View\M 16\80 lg
Normal View\M 16\90 lg
Normal View\M 16\100 lg
Normal View\M 16\110 lg
Normal View\M 16\120 lg
Normal View\M 16\130 lg
Normal View\M 16\140 lg
Normal View\M 16\150 lg
Normal View\M 20\16 lg
Normal View\M 20\20 lg
Normal View\M 20\25 lg
Normal View\M 20\30 lg
Normal View\M 20\35 lg
Normal View\M 20\40 lg
Normal View\M 20\45 lg
Normal View\M 20\50 lg
Normal View\M 20\55 lg
Normal View\M 20\60 lg
Normal View\M 20\65 lg
Normal View\M 20\70 lg
Normal View\M 20\80 lg
Normal View\M 20\90 lg
Normal View\M 20\100 lg
Normal View\M 20\110 lg
Normal View\M 20\120 lg
Normal View\M 20\130 lg
Normal View\M 20\140 lg

Normal View\M 20\150 lg
Normal View\M 20\160 lg
Normal View\M 20\200 lg
Normal View\M 20\180 lg
Normal View\M 24\16 lg
Normal View\M 24\20 lg
Normal View\M 24\25 lg
Normal View\M 24\30 lg
Normal View\M 24\35 lg
Normal View\M 24\40 lg
Normal View\M 24\45 lg
Normal View\M 24\50 lg
Normal View\M 24\55 lg
Normal View\M 24\60 lg
Normal View\M 24\65 lg
Normal View\M 24\70 lg
Normal View\M 24\80 lg
Normal View\M 24\90 lg
Normal View\M 24\100 lg
Normal View\M 24\110 lg
Normal View\M 24\120 lg
Normal View\M 24\130 lg
Normal View\M 24\140 lg
Normal View\M 24\150 lg
Normal View\M 24\160 lg
Normal View\M 24\180 lg
Normal View\M 24\200 lg
Normal View\M 30\35 lg
Normal View\M 30\40 lg
Normal View\M 30\45 lg
Normal View\M 30\50 lg
Normal View\M 30\55 lg
Normal View\M 30\60 lg
Normal View\M 30\65 lg
Normal View\M 30\70 lg
Normal View\M 30\80 lg
Normal View\M 30\90 lg
Normal View\M 30\100 lg
Normal View\M 30\110 lg
Normal View\M 30\120 lg
Normal View\M 30\130 lg
Normal View\M 30\140 lg
Normal View\M 30\150 lg
Normal View\M 30\160 lg
Normal View\M 30\180 lg
Normal View\M 30\200 lg
Normal View\M 36\35 lg
Normal View\M 36\40 lg
Normal View\M 36\45 lg
Normal View\M 36\50 lg
Normal View\M 36\55 lg

Normal View\M 36\60 lg
Normal View\M 36\65 lg
Normal View\M 36\70 lg
Normal View\M 36\80 lg
Normal View\M 36\90 lg
Normal View\M 36\100 lg
Normal View\M 36\110 lg
Normal View\M 36\120 lg
Normal View\M 36\130 lg
Normal View\M 36\140 lg
Normal View\M 36\150 lg
Normal View\M 36\160 lg
Normal View\M 36\180 lg
Normal View\M 36\200 lg
Normal View\M 42\40 lg
Normal View\M 42\45 lg
Normal View\M 42\50 lg
Normal View\M 42\55 lg
Normal View\M 42\60 lg
Normal View\M 42\65 lg
Normal View\M 42\70 lg
Normal View\M 42\80 lg
Normal View\M 42\90 lg
Normal View\M 42\100 lg
Normal View\M 42\110 lg
Normal View\M 42\120 lg
Normal View\M 42\130 lg
Normal View\M 42\140 lg
Normal View\M 42\150 lg
Normal View\M 42\160 lg
Normal View\M 42\180 lg
Normal View\M 42\200 lg
Normal View\M 48\40 lg
Normal View\M 48\45 lg
Normal View\M 48\50 lg
Normal View\M 48\55 lg
Normal View\M 48\60 lg
Normal View\M 48\65 lg
Normal View\M 48\70 lg
Normal View\M 48\80 lg
Normal View\M 48\90 lg
Normal View\M 48\100 lg
Normal View\M 48\110 lg
Normal View\M 48\120 lg
Normal View\M 48\130 lg
Normal View\M 48\140 lg
Normal View\M 48\150 lg
Normal View\M 48\160 lg
Normal View\M 48\180 lg
Normal View\M 48\200 lg
Plan View\M 1.6

Plan View\M 2
Plan View\M 2.5
Plan View\M 3
Plan View\M 4
Plan View\M 5
Plan View\M 6
Plan View\M 8
Plan View\M 10
Plan View\M 12
Plan View\M 16
Plan View\M 20
Plan View\M 24
Plan View\M 30
Plan View\M 36
Plan View\M 42
Plan View\M 48
Side View\M 1.6
Side View\M 2
Side View\M 2.5
Side View\M 3
Side View\M 4
Side View\M 5
Side View\M 6
Side View\M 8
Side View\M 10
Side View\M 12
Side View\M 16
Side View\M 20
Side View\M 24
Side View\M 30
Side View\M 36
Side View\M 42
Side View\M 48

(325 symbols)

Screws DIN 7968

For TommySoftware® CAD/DRAW 3 and CAD/DRAW 4 only!!!

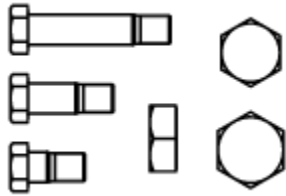

Library Contents

Normal View\M 12\30 lg
Normal View\M 12\35 lg
Normal View\M 12\40 lg
Normal View\M 12\45 lg
Normal View\M 12\50 lg
Normal View\M 12\55 lg
Normal View\M 12\60 lg
Normal View\M 12\65 lg
Normal View\M 12\70 lg
Normal View\M 12\120 lg
Normal View\M 12\115 lg
Normal View\M 12\110 lg
Normal View\M 12\105 lg
Normal View\M 12\100 lg
Normal View\M 12\95 lg
Normal View\M 12\90 lg
Normal View\M 12\85 lg
Normal View\M 12\80 lg
Normal View\M 12\75 lg
Normal View\M 16\35 lg
Normal View\M 16\40 lg
Normal View\M 16\45 lg
Normal View\M 16\50 lg
Normal View\M 16\55 lg
Normal View\M 16\60 lg
Normal View\M 16\65 lg
Normal View\M 16\70 lg
Normal View\M 16\75 lg
Normal View\M 16\80 lg
Normal View\M 16\85 lg
Normal View\M 16\90 lg
Normal View\M 16\95 lg
Normal View\M 16\100 lg
Normal View\M 16\105 lg
Normal View\M 16\110 lg
Normal View\M 16\115 lg
Normal View\M 16\120 lg

Normal View\M 16\125 lg
Normal View\M 16\130 lg
Normal View\M 16\135 lg
Normal View\M 16\140 lg
Normal View\M 16\145 lg
Normal View\M 16\150 lg
Normal View\M 16\155 lg
Normal View\M 16\160 lg
Normal View\M 20\40 lg
Normal View\M 20\45 lg
Normal View\M 20\50 lg
Normal View\M 20\55 lg
Normal View\M 20\60 lg
Normal View\M 20\65 lg
Normal View\M 20\70 lg
Normal View\M 20\75 lg
Normal View\M 20\80 lg
Normal View\M 20\85 lg
Normal View\M 20\90 lg
Normal View\M 20\95 lg
Normal View\M 20\100 lg
Normal View\M 20\105 lg
Normal View\M 20\110 lg
Normal View\M 20\115 lg
Normal View\M 20\120 lg
Normal View\M 20\125 lg
Normal View\M 20\130 lg
Normal View\M 20\135 lg
Normal View\M 20\140 lg
Normal View\M 20\145 lg
Normal View\M 20\150 lg
Normal View\M 20\155 lg
Normal View\M 20\160 lg
Normal View\M 20\165 lg
Normal View\M 20\170 lg
Normal View\M 20\175 lg
Normal View\M 20\180 lg
Normal View\M 22\45 lg
Normal View\M 22\50 lg
Normal View\M 22\55 lg
Normal View\M 22\60 lg
Normal View\M 22\65 lg
Normal View\M 22\70 lg
Normal View\M 22\75 lg
Normal View\M 22\80 lg
Normal View\M 22\85 lg
Normal View\M 24\50 lg
Normal View\M 24\55 lg
Normal View\M 24\60 lg
Normal View\M 24\65 lg
Normal View\M 24\70 lg

Normal View\M 24\75 lg
Normal View\M 24\80 lg
Normal View\M 24\85 lg
Normal View\M 24\90 lg
Normal View\M 24\95 lg
Normal View\M 24\100 lg
Normal View\M 24\105 lg
Normal View\M 24\110 lg
Normal View\M 24\115 lg
Normal View\M 24\120 lg
Normal View\M 24\125 lg
Normal View\M 24\130 lg
Normal View\M 24\135 lg
Normal View\M 24\140 lg
Normal View\M 24\145 lg
Normal View\M 24\150 lg
Normal View\M 24\155 lg
Normal View\M 24\160 lg
Normal View\M 24\165 lg
Normal View\M 24\170 lg
Normal View\M 24\175 lg
Normal View\M 24\180 lg
Normal View\M 24\185 lg
Normal View\M 24\190 lg
Normal View\M 24\195 lg
Normal View\M 24\200 lg
Normal View\M 27\60 lg
Normal View\M 27\65 lg
Normal View\M 27\70 lg
Normal View\M 27\75 lg
Normal View\M 27\80 lg
Normal View\M 27\85 lg
Normal View\M 27\90 lg
Normal View\M 27\95 lg
Normal View\M 27\100 lg
Normal View\M 27\105 lg
Normal View\M 27\110 lg
Normal View\M 27\115 lg
Normal View\M 27\120 lg
Normal View\M 27\125 lg
Normal View\M 27\130 lg
Normal View\M 27\200 lg
Normal View\M 27\195 lg
Normal View\M 27\190 lg
Normal View\M 27\185 lg
Normal View\M 27\180 lg
Normal View\M 27\175 lg
Normal View\M 27\170 lg
Normal View\M 27\165 lg
Normal View\M 27\160 lg
Normal View\M 27\155 lg

Normal View\M 27\150 lg
Normal View\M 27\145 lg
Normal View\M 27\140 lg
Normal View\M 27\135 lg
Normal View\M 30\70 lg
Normal View\M 30\75 lg
Normal View\M 30\80 lg
Normal View\M 30\85 lg
Normal View\M 30\90 lg
Normal View\M 30\95 lg
Normal View\M 30\100 lg
Normal View\M 30\105 lg
Normal View\M 30\110 lg
Normal View\M 30\115 lg
Normal View\M 30\120 lg
Normal View\M 30\125 lg
Normal View\M 30\130 lg
Normal View\M 30\135 lg
Normal View\M 30\140 lg
Normal View\M 30\145 lg
Normal View\M 30\150 lg
Normal View\M 30\155 lg
Normal View\M 30\160 lg
Normal View\M 30\165 lg
Normal View\M 30\170 lg
Normal View\M 30\175 lg
Normal View\M 30\180 lg
Normal View\M 30\185 lg
Normal View\M 30\190 lg
Normal View\M 30\195 lg
Normal View\M 30\200 lg
Plan View\M 12
Plan View\M 16
Plan View\M 20
Plan View\M 24
Plan View\M 30
Plan View\M 22
Plan View\M 27
Side View\M 12
Side View\M 16
Side View\M 20
Side View\M 24
Side View\M 30
Side View\M 22
Side View\M 27

(184 symbols)

Screws DIN 7991

For TommySoftware® CAD/DRAW 3 and CAD/DRAW 4 only!!!

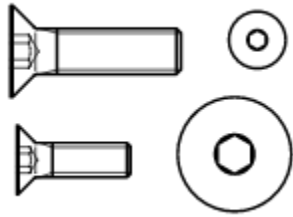

Library Contents

Normal View\M 3\8 lg
Normal View\M 3\10 lg
Normal View\M 3\12 lg
Normal View\M 3\16 lg
Normal View\M 3\20 lg
Normal View\M 3\25 lg
Normal View\M 3\30 lg
Normal View\M 4\8 lg
Normal View\M 4\10 lg
Normal View\M 4\12 lg
Normal View\M 4\16 lg
Normal View\M 4\20 lg
Normal View\M 4\25 lg
Normal View\M 4\30 lg
Normal View\M 4\35 lg
Normal View\M 4\40 lg
Normal View\M 5\8 lg
Normal View\M 5\10 lg
Normal View\M 5\12 lg
Normal View\M 5\16 lg
Normal View\M 5\20 lg
Normal View\M 5\25 lg
Normal View\M 5\30 lg
Normal View\M 5\35 lg
Normal View\M 5\40 lg
Normal View\M 5\50 lg
Normal View\M 6\8 lg
Normal View\M 6\10 lg
Normal View\M 6\12 lg
Normal View\M 6\16 lg
Normal View\M 6\20 lg
Normal View\M 6\25 lg
Normal View\M 6\30 lg
Normal View\M 6\35 lg
Normal View\M 6\40 lg
Normal View\M 6\50 lg
Normal View\M 8\10 lg

Normal View\M 8\12 lg
Normal View\M 8\16 lg
Normal View\M 8\20 lg
Normal View\M 8\25 lg
Normal View\M 8\30 lg
Normal View\M 8\35 lg
Normal View\M 8\40 lg
Normal View\M 8\50 lg
Normal View\M 8\60 lg
Normal View\M 10\12 lg
Normal View\M 10\16 lg
Normal View\M 10\20 lg
Normal View\M 10\25 lg
Normal View\M 10\30 lg
Normal View\M 10\35 lg
Normal View\M 10\40 lg
Normal View\M 10\50 lg
Normal View\M 10\60 lg
Normal View\M 10\70 lg
Normal View\M 12\20 lg
Normal View\M 12\25 lg
Normal View\M 12\30 lg
Normal View\M 12\35 lg
Normal View\M 12\40 lg
Normal View\M 12\50 lg
Normal View\M 12\60 lg
Normal View\M 12\70 lg
Normal View\M 16\30 lg
Normal View\M 16\35 lg
Normal View\M 16\40 lg
Normal View\M 16\50 lg
Normal View\M 16\60 lg
Normal View\M 16\70 lg
Normal View\M 16\80 lg
Normal View\M 16\90 lg
Normal View\M 20\35 lg
Normal View\M 20\40 lg
Normal View\M 20\50 lg
Normal View\M 20\60 lg
Normal View\M 20\70 lg
Normal View\M 20\80 lg
Normal View\M 20\90 lg
Normal View\M 20\100 lg
Normal View\M 24\50 lg
Normal View\M 24\60 lg
Normal View\M 24\70 lg
Normal View\M 24\80 lg
Normal View\M 24\90 lg
Normal View\M 24\100 lg
Side View\M 3
Side View\M 4

Side View\M 5
Side View\M 6
Side View\M 8
Side View\M 10
Side View\M 12
Side View\M 16
Side View\M 20
Side View\M 24

(96 symbols)

Screw Heads

For TommySoftware® CAD/DRAW 3 and CAD/DRAW 4 only!!!

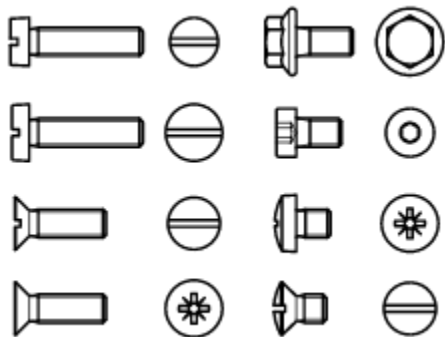

Library Contents

DIN 84\Normal View\M 1
DIN 84\Normal View\M 1.2
DIN 84\Normal View\M 1.4
DIN 84\Normal View\M 1.6
DIN 84\Normal View\M 2
DIN 84\Normal View\M 2.5
DIN 84\Normal View\M 3
DIN 84\Normal View\M 4
DIN 84\Normal View\M 5
DIN 84\Normal View\M 6
DIN 84\Normal View\M 8
DIN 84\Normal View\M 10
DIN 84\Side View\M 1
DIN 84\Side View\M 1.2
DIN 84\Side View\M 1.4
DIN 84\Side View\M 1.6
DIN 84\Side View\M 2
DIN 84\Side View\M 2.5
DIN 84\Side View\M 3
DIN 84\Side View\M 4
DIN 84\Side View\M 5
DIN 84\Side View\M 6
DIN 84\Side View\M 8
DIN 84\Side View\M 10
DIN 85\Normal View\M 3
DIN 85\Normal View\M 4
DIN 85\Normal View\M 5
DIN 85\Normal View\M 6
DIN 85\Side View\M 3
DIN 85\Side View\M 4
DIN 85\Side View\M 5
DIN 85\Side View\M 6
DIN 963\Normal View\M 1

DIN 963\Normal View\M 1.2
DIN 963\Normal View\M 1.4
DIN 963\Normal View\M 1.6
DIN 963\Normal View\M 2
DIN 963\Normal View\M 2.5
DIN 963\Normal View\M 3
DIN 963\Normal View\M 4
DIN 963\Normal View\M 5
DIN 963\Normal View\M 6
DIN 963\Normal View\M 8
DIN 963\Normal View\M 10
DIN 963\Normal View\M 12
DIN 963\Normal View\M 16
DIN 963\Normal View\M 20
DIN 963\Side View\M 20
DIN 963\Side View\M 16
DIN 963\Side View\M 12
DIN 963\Side View\M 10
DIN 963\Side View\M 8
DIN 963\Side View\M 6
DIN 963\Side View\M 5
DIN 963\Side View\M 4
DIN 963\Side View\M 3
DIN 963\Side View\M 2.5
DIN 963\Side View\M 2
DIN 963\Side View\M 1.6
DIN 963\Side View\M 1.4
DIN 963\Side View\M 1.2
DIN 963\Side View\M 1
DIN 964\Normal View\M 1
DIN 964\Normal View\M 1.2
DIN 964\Normal View\M 1.4
DIN 964\Normal View\M 1.6
DIN 964\Normal View\M 2
DIN 964\Normal View\M 2.5
DIN 964\Normal View\M 3
DIN 964\Normal View\M 4
DIN 964\Normal View\M 5
DIN 964\Normal View\M 6
DIN 964\Normal View\M 8
DIN 964\Normal View\M 10
DIN 964\Side View\M 1
DIN 964\Side View\M 1.2
DIN 964\Side View\M 1.4
DIN 964\Side View\M 1.6
DIN 964\Side View\M 2
DIN 964\Side View\M 2.5
DIN 964\Side View\M 3
DIN 964\Side View\M 4
DIN 964\Side View\M 5
DIN 964\Side View\M 6

DIN 964\Side View\M 8
DIN 964\Side View\M 10
DIN 965\Side View\M 1.6
DIN 965\Side View\M 2
DIN 965\Side View\M 2.5
DIN 965\Side View\M 3
DIN 965\Side View\M 4
DIN 965\Side View\M 5
DIN 965\Side View\M 6
DIN 965\Side View\M 8
DIN 965\Side View\M 10
DIN 965\Normal View\M 1.6
DIN 965\Normal View\M 2
DIN 965\Normal View\M 2.5
DIN 965\Normal View\M 3
DIN 965\Normal View\M 4
DIN 965\Normal View\M 5
DIN 965\Normal View\M 6
DIN 965\Normal View\M 8
DIN 965\Normal View\M 10
DIN 6921\Normal View\M 5
DIN 6921\Normal View\M 6
DIN 6921\Normal View\M 8
DIN 6921\Normal View\M 10
DIN 6921\Normal View\M 12
DIN 6921\Normal View\M 14
DIN 6921\Normal View\M 16
DIN 6921\Normal View\M 20
DIN 6921\Side View\M 5
DIN 6921\Side View\M 6
DIN 6921\Side View\M 8
DIN 6921\Side View\M 10
DIN 6921\Side View\M 12
DIN 6921\Side View\M 14
DIN 6921\Side View\M 16
DIN 6921\Side View\M 20
DIN 7984\Normal View\M 3
DIN 7984\Normal View\M 4
DIN 7984\Normal View\M 5
DIN 7984\Normal View\M 6
DIN 7984\Normal View\M 8
DIN 7984\Normal View\M 10
DIN 7984\Side View\M 3
DIN 7984\Side View\M 4
DIN 7984\Side View\M 5
DIN 7984\Side View\M 6
DIN 7984\Side View\M 8
DIN 7984\Side View\M 10
DIN 7985\Normal View\M 1.6
DIN 7985\Normal View\M 2
DIN 7985\Normal View\M 2.5

DIN 7985\Normal View\M 3
DIN 7985\Normal View\M 4
DIN 7985\Normal View\M 5
DIN 7985\Normal View\M 6
DIN 7985\Normal View\M 8
DIN 7985\Normal View\M 10
DIN 7985\Side View\M 1.6
DIN 7985\Side View\M 2
DIN 7985\Side View\M 2.5
DIN 7985\Side View\M 3
DIN 7985\Side View\M 4
DIN 7985\Side View\M 5
DIN 7985\Side View\M 6
DIN 7985\Side View\M 8
DIN 7985\Side View\M 10

(150 symbols)

Nuts

For TommySoftware® CAD/DRAW 3 and CAD/DRAW 4 only!!!

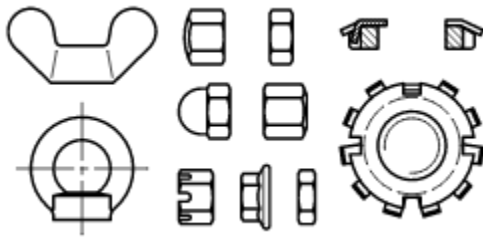

Library Contents

DIN 315\Normal View\M 4
DIN 315\Normal View\M 5
DIN 315\Normal View\M 6
DIN 315\Normal View\M 8
DIN 315\Normal View\M 10
DIN 315\Normal View\M 12
DIN 315\Normal View\M 16
DIN 315\Normal View\M 20
DIN 315\Normal View\M 24
DIN 315\Plan View\M 4
DIN 315\Plan View\M 5
DIN 315\Plan View\M 6
DIN 315\Plan View\M 8
DIN 315\Plan View\M 10
DIN 315\Plan View\M 12
DIN 315\Plan View\M 16
DIN 315\Plan View\M 20
DIN 315\Plan View\M 24
DIN 315\Side View\M 4
DIN 315\Side View\M 5
DIN 315\Side View\M 6
DIN 315\Side View\M 8
DIN 315\Side View\M 10
DIN 315\Side View\M 12
DIN 315\Side View\M 16
DIN 315\Side View\M 20
DIN 315\Side View\M 24
DIN 582\Normal View\M 8
DIN 582\Normal View\M 10
DIN 582\Normal View\M 12
DIN 582\Normal View\M 16
DIN 582\Normal View\M 20
DIN 582\Normal View\M 24
DIN 582\Normal View\M 30
DIN 582\Normal View\M 36
DIN 582\Normal View\M 42

DIN 582\Normal View\M 48
DIN 582\Normal View\M 56
DIN 582\Normal View\M 64
DIN 582\Normal View\M 72
DIN 582\Normal View\M 80
DIN 582\Normal View\M 100
DIN 582\Plan View\M 8
DIN 582\Plan View\M 10
DIN 582\Plan View\M 12
DIN 582\Plan View\M 16
DIN 582\Plan View\M 20
DIN 582\Plan View\M 24
DIN 582\Plan View\M 30
DIN 582\Plan View\M 36
DIN 582\Plan View\M 42
DIN 582\Plan View\M 48
DIN 582\Plan View\M 56
DIN 582\Plan View\M 64
DIN 582\Plan View\M 72
DIN 582\Plan View\M 80
DIN 582\Plan View\M100
DIN 582\Side View\M 8
DIN 582\Side View\M 10
DIN 582\Side View\M 12
DIN 582\Side View\M 16
DIN 582\Side View\M 20
DIN 582\Side View\M 24
DIN 582\Side View\M 30
DIN 582\Side View\M 36
DIN 582\Side View\M 42
DIN 582\Side View\M 48
DIN 582\Side View\M 56
DIN 582\Side View\M 64
DIN 582\Side View\M 72
DIN 582\Side View\M 80
DIN 582\Side View\M 100
DIN 917\Normal View\M 4
DIN 917\Normal View\M 5
DIN 917\Normal View\M 6
DIN 917\Normal View\M 8
DIN 917\Normal View\M 10
DIN 917\Normal View\M 12
DIN 917\Normal View\M 16
DIN 917\Normal View\M 20
DIN 917\Normal View\M 24
DIN 917\Normal View\M 30
DIN 917\Normal View\M 36
DIN 917\Normal View\M 42
DIN 917\Normal View\M 48
DIN 917\Side View\M 4
DIN 917\Side View\M 5

DIN 917\Side View\M 6
DIN 917\Side View\M 8
DIN 917\Side View\M 10
DIN 917\Side View\M 12
DIN 917\Side View\M 16
DIN 917\Side View\M 20
DIN 917\Side View\M 24
DIN 917\Side View\M 30
DIN 917\Side View\M 36
DIN 917\Side View\M 42
DIN 917\Side View\M 48
DIN 917\Plan View\M 4
DIN 917\Plan View\M 5
DIN 917\Plan View\M 6
DIN 917\Plan View\M 8
DIN 917\Plan View\M 10
DIN 917\Plan View\M 12
DIN 917\Plan View\M 16
DIN 917\Plan View\M 20
DIN 917\Plan View\M 24
DIN 917\Plan View\M 30
DIN 917\Plan View\M 36
DIN 917\Plan View\M 42
DIN 917\Plan View\M 48
DIN 934\Normal View\M 1
DIN 934\Normal View\M 1.2
DIN 934\Normal View\M 1.4
DIN 934\Normal View\M 1.6
DIN 934\Normal View\M 2
DIN 934\Normal View\M 2.5
DIN 934\Normal View\M 3
DIN 934\Normal View\M 4
DIN 934\Normal View\M 5
DIN 934\Normal View\M 6
DIN 934\Normal View\M 8
DIN 934\Normal View\M 10
DIN 934\Normal View\M 12
DIN 934\Normal View\M 16
DIN 934\Normal View\M 20
DIN 934\Normal View\M 24
DIN 934\Normal View\M 30
DIN 934\Normal View\M 36
DIN 934\Normal View\M 42
DIN 934\Normal View\M 48
DIN 934\Normal View\M 56
DIN 934\Normal View\M 64
DIN 934\Normal View\M 72
DIN 934\Normal View\M 80
DIN 934\Normal View\M 90
DIN 934\Normal View\M 100
DIN 934\Side View\M 1

DIN 934\Side View\M 1.2
DIN 934\Side View\M 1.4
DIN 934\Side View\M 1.6
DIN 934\Side View\M 2
DIN 934\Side View\M 2.5
DIN 934\Side View\M 3
DIN 934\Side View\M 4
DIN 934\Side View\M 5
DIN 934\Side View\M 6
DIN 934\Side View\M 8
DIN 934\Side View\M 10
DIN 934\Side View\M 12
DIN 934\Side View\M 16
DIN 934\Side View\M 20
DIN 934\Side View\M 24
DIN 934\Side View\M 30
DIN 934\Side View\M 36
DIN 934\Side View\M 42
DIN 934\Side View\M 48
DIN 934\Side View\M 56
DIN 934\Side View\M 64
DIN 934\Side View\M 72
DIN 934\Side View\M 80
DIN 934\Side View\M 90
DIN 934\Side View\M100
DIN 934\Plan View\M 1
DIN 934\Plan View\M 1.2
DIN 934\Plan View\M 1.4
DIN 934\Plan View\M 1.6
DIN 934\Plan View\M 2
DIN 934\Plan View\M 2.5
DIN 934\Plan View\M 3
DIN 934\Plan View\M 4
DIN 934\Plan View\M 5
DIN 934\Plan View\M 6
DIN 934\Plan View\M 8
DIN 934\Plan View\M 10
DIN 934\Plan View\M 12
DIN 934\Plan View\M 16
DIN 934\Plan View\M 20
DIN 934\Plan View\M 24
DIN 934\Plan View\M 30
DIN 934\Plan View\M 36
DIN 934\Plan View\M 42
DIN 934\Plan View\M 48
DIN 934\Plan View\M 56
DIN 934\Plan View\M 64
DIN 934\Plan View\M 72
DIN 934\Plan View\M 80
DIN 934\Plan View\M 90
DIN 934\Plan View\M 100

DIN 935\Normal View\M 4
DIN 935\Normal View\M 5
DIN 935\Normal View\M 6
DIN 935\Normal View\M 8
DIN 935\Normal View\M 10
DIN 935\Normal View\M 12
DIN 935\Normal View\M 16
DIN 935\Normal View\M 20
DIN 935\Normal View\M 24
DIN 935\Normal View\M 30
DIN 935\Normal View\M 36
DIN 935\Normal View\M 42
DIN 935\Normal View\M 48
DIN 935\Normal View\M 56
DIN 935\Normal View\M 64
DIN 935\Normal View\M 72
DIN 935\Normal View\M 80
DIN 935\Normal View\M 90
DIN 935\Normal View\M 100
DIN 935\Plan View\M 4
DIN 935\Plan View\M 5
DIN 935\Plan View\M 6
DIN 935\Plan View\M 8
DIN 935\Plan View\M 10
DIN 935\Plan View\M 12
DIN 935\Plan View\M 16
DIN 935\Plan View\M 20
DIN 935\Plan View\M 24
DIN 935\Plan View\M 30
DIN 935\Plan View\M 36
DIN 935\Plan View\M 42
DIN 935\Plan View\M 48
DIN 935\Plan View\M 56
DIN 935\Plan View\M 64
DIN 935\Plan View\M 48
DIN 935\Plan View\M 80
DIN 935\Plan View\M 90
DIN 935\Plan View\M 100
DIN 935\Side View\M 4
DIN 935\Side View\M 5
DIN 935\Side View\M 6
DIN 935\Side View\M 8
DIN 935\Side View\M 10
DIN 935\Side View\M 12
DIN 935\Side View\M 16
DIN 935\Side View\M 20
DIN 935\Side View\M 24
DIN 935\Side View\M 30
DIN 935\Side View\M 36
DIN 935\Side View\M 42
DIN 935\Side View\M 48

DIN 935\Side View\M 56
DIN 935\Side View\M 64
DIN 935\Side View\M 72
DIN 935\Side View\M 80
DIN 935\Side View\M 90
DIN 935\Side View\M 100
DIN 936\Normal View\M 8
DIN 936\Normal View\M 10
DIN 936\Normal View\M 12
DIN 936\Normal View\M 14
DIN 936\Normal View\M 16
DIN 936\Normal View\M 18
DIN 936\Normal View\M 20
DIN 936\Normal View\M 22
DIN 936\Normal View\M 24
DIN 936\Normal View\M 27
DIN 936\Normal View\M 30
DIN 936\Normal View\M 33
DIN 936\Normal View\M 36
DIN 936\Normal View\M 39
DIN 936\Normal View\M 42
DIN 936\Normal View\M 48
DIN 936\Normal View\M 52
DIN 936\Plan View\M 8
DIN 936\Plan View\M 10
DIN 936\Plan View\M 12
DIN 936\Plan View\M 14
DIN 936\Plan View\M 16
DIN 936\Plan View\M 18
DIN 936\Plan View\M 20
DIN 936\Plan View\M 22
DIN 936\Plan View\M 24
DIN 936\Plan View\M 27
DIN 936\Plan View\M 30
DIN 936\Plan View\M 33
DIN 936\Plan View\M 36
DIN 936\Plan View\M 39
DIN 936\Plan View\M 42
DIN 936\Plan View\M 48
DIN 936\Plan View\M 52
DIN 981\Section\M 10x0.75
DIN 981\Section\M 12x1
DIN 981\Section\M 15x1
DIN 981\Section\M 17x1
DIN 981\Section\M 20x1
DIN 981\Section\M 25x1.5
DIN 981\Section\M 30x1.5
DIN 981\Section\M 35x1.5
DIN 981\Section\M 40x1.5
DIN 981\Section\M 45x1.5
DIN 981\Section\M 50x1.5

DIN 981\Section\M 55x2
DIN 981\Section\M 60x2
DIN 981\Section\M 65x2
DIN 981\Section\M 70x2
DIN 981\Section\M 75x2
DIN 981\Section\M 80x2
DIN 936\Side View\M 8
DIN 936\Side View\M 10
DIN 936\Side View\M 12
DIN 936\Side View\M 14
DIN 936\Side View\M 16
DIN 936\Side View\M 18
DIN 936\Side View\M 20
DIN 936\Side View\M 22
DIN 936\Side View\M 24
DIN 936\Side View\M 27
DIN 936\Side View\M 30
DIN 936\Side View\M 33
DIN 936\Side View\M 36
DIN 936\Side View\M 39
DIN 936\Side View\M 42
DIN 936\Side View\M 48
DIN 936\Side View\M 52
DIN 981\Section\M 85x2
DIN 981\Section\M 90x2
DIN 981\Section\M 95x2
DIN 981\Section\M100x2
DIN 981\Section\M105x2
DIN 981\Section\M110x2
DIN 981\Section\M115x2
DIN 981\Section\M120x2 (KML24)
DIN 981\Section\M120x2 (KM24)
DIN 981\Section\M125x2
DIN 981\Section\M130x2 (KML26)
DIN 981\Section\M130x2 (KM26)
DIN 981\Section\M135x2
DIN 981\Section\M140x2 (KML28)
DIN 981\Section\M140x2 (KM28)
DIN 981\Section\M145x2
DIN 981\Section\M150x2 (KM30)
DIN 981\Section\M150x2 (KML30)
DIN 981\Side View\M 10x0.75
DIN 981\Side View\M 12x1
DIN 981\Side View\M 15x1
DIN 981\Side View\M 17x1
DIN 981\Side View\M 20x1
DIN 981\Side View\M 25x1.5
DIN 981\Side View\M 30x1.5
DIN 981\Side View\M 35x1.5
DIN 981\Side View\M 40x1.5
DIN 981\Side View\M 45x1.5

DIN 981\Side View\M 50x1.5
DIN 981\Side View\M 55x2
DIN 981\Side View\M 60x2
DIN 981\Side View\M 65x2
DIN 981\Side View\M 70x2
DIN 981\Side View\M 75x2
DIN 981\Side View\M 80x2
DIN 981\Side View\M 85x2
DIN 981\Side View\M 90x2
DIN 981\Side View\M 95x2
DIN 981\Side View\M100x2
DIN 981\Side View\M105x2
DIN 981\Side View\M110x2
DIN 981\Side View\M115x2
DIN 981\Side View\M120x2 (KML24)
DIN 981\Side View\M120x2 (KM24)
DIN 981\Side View\M150x2 (KM30)
DIN 981\Side View\M150x2 (KML30)
DIN 981\Side View\M145x2
DIN 981\Side View\M140x2 (KM28)
DIN 981\Side View\M140x2 (KML28)
DIN 981\Side View\M135x2
DIN 981\Side View\M130x2 (KM26)
DIN 981\Side View\M130x2 (KML26)
DIN 981\Side View\M125x2
DIN 1587\Normal View\M 4
DIN 1587\Normal View\M 5
DIN 1587\Normal View\M 6
DIN 1587\Normal View\M 8
DIN 1587\Normal View\M 10
DIN 1587\Normal View\M 12
DIN 1587\Normal View\M 16
DIN 1587\Normal View\M 20
DIN 1587\Normal View\M 24
DIN 1587\Plan View\M 4
DIN 1587\Plan View\M 5
DIN 1587\Plan View\M 6
DIN 1587\Plan View\M 8
DIN 1587\Plan View\M 10
DIN 1587\Plan View\M 12
DIN 1587\Plan View\M 16
DIN 1587\Plan View\M 20
DIN 1587\Plan View\M 24
DIN 1587\Side View\M 4
DIN 1587\Side View\M 5
DIN 1587\Side View\M 6
DIN 1587\Side View\M 8
DIN 1587\Side View\M 10
DIN 1587\Side View\M 12
DIN 1587\Side View\M 16
DIN 1587\Side View\M 20

DIN 1587\Side View\M 24
DIN 6330\Normal View\M 6
DIN 6330\Normal View\M 8
DIN 6330\Normal View\M 10
DIN 6330\Normal View\M 12
DIN 6330\Normal View\M 16
DIN 6330\Normal View\M 20
DIN 6330\Normal View\M 24
DIN 6330\Normal View\M 30
DIN 6330\Normal View\M 36
DIN 6330\Normal View\M 42
DIN 6330\Normal View\M 48
DIN 6330\Plan View\M 6
DIN 6330\Plan View\M 8
DIN 6330\Plan View\M 10
DIN 6330\Plan View\M 12
DIN 6330\Plan View\M 16
DIN 6330\Plan View\M 20
DIN 6330\Plan View\M 24
DIN 6330\Plan View\M 30
DIN 6330\Plan View\M 36
DIN 6330\Plan View\M 42
DIN 6330\Plan View\M 48
DIN 6330\Side View\M 6
DIN 6330\Side View\M 8
DIN 6330\Side View\M 10
DIN 6330\Side View\M 12
DIN 6330\Side View\M 16
DIN 6330\Side View\M 20
DIN 6330\Side View\M 24
DIN 6330\Side View\M 30
DIN 6330\Side View\M 36
DIN 6330\Side View\M 42
DIN 6330\Side View\M 48
DIN 6923\Normal View\M 5
DIN 6923\Normal View\M 6
DIN 6923\Normal View\M 8
DIN 6923\Normal View\M 10
DIN 6923\Normal View\M 12
DIN 6923\Normal View\M 14
DIN 6923\Normal View\M 16
DIN 6923\Normal View\M 20
DIN 6923\Side View\M 5
DIN 6923\Side View\M 6
DIN 6923\Side View\M 8
DIN 6923\Side View\M 10
DIN 6923\Side View\M 12
DIN 6923\Side View\M 14
DIN 6923\Side View\M 16
DIN 6923\Side View\M 20

(443 symbols)

Steel Sections

For TommySoftware® CAD/DRAW 3 and CAD/DRAW 4 only!!!



Library Contents

Steel Profiles\DIN 1022\Side View\LS 20x3
Steel Profiles\DIN 1022\Side View\LS 20x4
Steel Profiles\DIN 1022\Side View\LS 25x3
Steel Profiles\DIN 1022\Side View\LS 25x4
Steel Profiles\DIN 1022\Side View\LS 30x3
Steel Profiles\DIN 1022\Side View\LS 30x4
Steel Profiles\DIN 1022\Side View\LS 35x4
Steel Profiles\DIN 1022\Side View\LS 40x4
Steel Profiles\DIN 1022\Side View\LS 40x5
Steel Profiles\DIN 1022\Side View\LS 45x5
Steel Profiles\DIN 1022\Side View\LS 50x5
Steel Profiles\DIN 1022\Normal View\LS 20x3
Steel Profiles\DIN 1022\Normal View\LS 20x4
Steel Profiles\DIN 1022\Normal View\LS 25x3
Steel Profiles\DIN 1022\Normal View\LS 25x4
Steel Profiles\DIN 1022\Normal View\LS 30x3
Steel Profiles\DIN 1022\Normal View\LS 30x4
Steel Profiles\DIN 1022\Normal View\LS 35x4
Steel Profiles\DIN 1022\Normal View\LS 40x4
Steel Profiles\DIN 1022\Normal View\LS 40x5
Steel Profiles\DIN 1022\Normal View\LS 45x5
Steel Profiles\DIN 1022\Normal View\LS 50x5
Steel Profiles\DIN 1022\Plan View\LS 20x3
Steel Profiles\DIN 1022\Plan View\LS 20x4
Steel Profiles\DIN 1022\Plan View\LS 25x3
Steel Profiles\DIN 1022\Plan View\LS 25x4
Steel Profiles\DIN 1022\Plan View\LS 30x3
Steel Profiles\DIN 1022\Plan View\LS 30x4
Steel Profiles\DIN 1022\Plan View\LS 35x4
Steel Profiles\DIN 1022\Plan View\LS 40x4
Steel Profiles\DIN 1022\Plan View\LS 40x5
Steel Profiles\DIN 1022\Plan View\LS 45x5
Steel Profiles\DIN 1022\Plan View\LS 50x5
Steel Profiles\DIN 1024\Side View\T 20
Steel Profiles\DIN 1024\Side View\T 25
Steel Profiles\DIN 1024\Side View\T 30

Steel Profiles\DIN 1024\Side View\T 35
Steel Profiles\DIN 1024\Side View\T 40
Steel Profiles\DIN 1024\Side View\T 45
Steel Profiles\DIN 1024\Side View\T 50
Steel Profiles\DIN 1024\Side View\T 60
Steel Profiles\DIN 1024\Side View\T 70
Steel Profiles\DIN 1024\Side View\T 80
Steel Profiles\DIN 1024\Side View\T 90
Steel Profiles\DIN 1024\Side View\T 100
Steel Profiles\DIN 1024\Side View\T 120
Steel Profiles\DIN 1024\Side View\T 140
Steel Profiles\DIN 1024\Side View\TB 30
Steel Profiles\DIN 1024\Side View\TB 35
Steel Profiles\DIN 1024\Side View\TB 40
Steel Profiles\DIN 1024\Side View\TB 50
Steel Profiles\DIN 1024\Side View\TB 60
Steel Profiles\DIN 1024\Normal View\T 20
Steel Profiles\DIN 1024\Normal View\T 25
Steel Profiles\DIN 1024\Normal View\T 30
Steel Profiles\DIN 1024\Normal View\T 35
Steel Profiles\DIN 1024\Normal View\T 40
Steel Profiles\DIN 1024\Normal View\T 45
Steel Profiles\DIN 1024\Normal View\T 50
Steel Profiles\DIN 1024\Normal View\T 60
Steel Profiles\DIN 1024\Normal View\T 70
Steel Profiles\DIN 1024\Normal View\T 80
Steel Profiles\DIN 1024\Normal View\T 90
Steel Profiles\DIN 1024\Normal View\T 100
Steel Profiles\DIN 1024\Normal View\T 120
Steel Profiles\DIN 1024\Normal View\T 140
Steel Profiles\DIN 1024\Normal View\TB 30
Steel Profiles\DIN 1024\Normal View\TB 35
Steel Profiles\DIN 1024\Normal View\TB 40
Steel Profiles\DIN 1024\Normal View\TB 50
Steel Profiles\DIN 1024\Normal View\TB 60
Steel Profiles\DIN 1024\Plan View\T 20
Steel Profiles\DIN 1024\Plan View\T 25
Steel Profiles\DIN 1024\Plan View\T 30
Steel Profiles\DIN 1024\Plan View\T 35
Steel Profiles\DIN 1024\Plan View\T 40
Steel Profiles\DIN 1024\Plan View\T 45
Steel Profiles\DIN 1024\Plan View\T 50
Steel Profiles\DIN 1024\Plan View\T 60
Steel Profiles\DIN 1024\Plan View\T 70
Steel Profiles\DIN 1024\Plan View\T 80
Steel Profiles\DIN 1024\Plan View\T 90
Steel Profiles\DIN 1024\Plan View\T 100
Steel Profiles\DIN 1024\Plan View\T 120
Steel Profiles\DIN 1024\Plan View\T 140
Steel Profiles\DIN 1024\Plan View\TB 30
Steel Profiles\DIN 1024\Plan View\TB 35

Steel Profiles\DIN 1024\Plan View\TB 40
Steel Profiles\DIN 1024\Plan View\TB 50
Steel Profiles\DIN 1024\Plan View\TB 60
Steel Profiles\DIN 1025/1\Side View\I 80
Steel Profiles\DIN 1025/1\Side View\I 100
Steel Profiles\DIN 1025/1\Side View\I 120
Steel Profiles\DIN 1025/1\Side View\I 140
Steel Profiles\DIN 1025/1\Side View\I 160
Steel Profiles\DIN 1025/1\Side View\I 180
Steel Profiles\DIN 1025/1\Side View\I 200
Steel Profiles\DIN 1025/1\Side View\I 220
Steel Profiles\DIN 1025/1\Side View\I 240
Steel Profiles\DIN 1025/1\Side View\I 260
Steel Profiles\DIN 1025/1\Side View\I 280
Steel Profiles\DIN 1025/1\Side View\I 300
Steel Profiles\DIN 1025/1\Side View\I 320
Steel Profiles\DIN 1025/1\Side View\I 340
Steel Profiles\DIN 1025/1\Side View\I 360
Steel Profiles\DIN 1025/1\Side View\I 380
Steel Profiles\DIN 1025/1\Side View\I 400
Steel Profiles\DIN 1025/1\Side View\I 425
Steel Profiles\DIN 1025/1\Side View\I 450
Steel Profiles\DIN 1025/1\Side View\I 475
Steel Profiles\DIN 1025/1\Side View\I 500
Steel Profiles\DIN 1025/1\Side View\I 550
Steel Profiles\DIN 1025/1\Side View\I 600
Steel Profiles\DIN 1025/1\Normal View\I 80
Steel Profiles\DIN 1025/1\Normal View\I 100
Steel Profiles\DIN 1025/1\Normal View\I 120
Steel Profiles\DIN 1025/1\Normal View\I 140
Steel Profiles\DIN 1025/1\Normal View\I 160
Steel Profiles\DIN 1025/1\Normal View\I 180
Steel Profiles\DIN 1025/1\Normal View\I 200
Steel Profiles\DIN 1025/1\Normal View\I 220
Steel Profiles\DIN 1025/1\Normal View\I 240
Steel Profiles\DIN 1025/1\Normal View\I 260
Steel Profiles\DIN 1025/1\Normal View\I 280
Steel Profiles\DIN 1025/1\Normal View\I 300
Steel Profiles\DIN 1025/1\Normal View\I 320
Steel Profiles\DIN 1025/1\Normal View\I 340
Steel Profiles\DIN 1025/1\Normal View\I 600
Steel Profiles\DIN 1025/1\Normal View\I 550
Steel Profiles\DIN 1025/1\Normal View\I 500
Steel Profiles\DIN 1025/1\Normal View\I 475
Steel Profiles\DIN 1025/1\Normal View\I 450
Steel Profiles\DIN 1025/1\Normal View\I 425
Steel Profiles\DIN 1025/1\Normal View\I 400
Steel Profiles\DIN 1025/1\Normal View\I 380
Steel Profiles\DIN 1025/1\Normal View\I 360
Steel Profiles\DIN 1025/1\Plan View\I 80
Steel Profiles\DIN 1025/1\Plan View\I 100

Steel Profiles\DIN 1025/1\Plan View\I 120
Steel Profiles\DIN 1025/1\Plan View\I 140
Steel Profiles\DIN 1025/1\Plan View\I 160
Steel Profiles\DIN 1025/1\Plan View\I 180
Steel Profiles\DIN 1025/1\Plan View\I 200
Steel Profiles\DIN 1025/1\Plan View\I 220
Steel Profiles\DIN 1025/1\Plan View\I 240
Steel Profiles\DIN 1025/1\Plan View\I 260
Steel Profiles\DIN 1025/1\Plan View\I 280
Steel Profiles\DIN 1025/1\Plan View\I 300
Steel Profiles\DIN 1025/1\Plan View\I 320
Steel Profiles\DIN 1025/1\Plan View\I 340
Steel Profiles\DIN 1025/1\Plan View\I 360
Steel Profiles\DIN 1025/1\Plan View\I 380
Steel Profiles\DIN 1025/1\Plan View\I 400
Steel Profiles\DIN 1025/1\Plan View\I 425
Steel Profiles\DIN 1025/1\Plan View\I 450
Steel Profiles\DIN 1025/1\Plan View\I 475
Steel Profiles\DIN 1025/1\Plan View\I 500
Steel Profiles\DIN 1025/1\Plan View\I 550
Steel Profiles\DIN 1025/1\Plan View\I 600
Steel Profiles\DIN 1025/2\Side View\IPB 100
Steel Profiles\DIN 1025/2\Side View\IPB 120
Steel Profiles\DIN 1025/2\Side View\IPB 140
Steel Profiles\DIN 1025/2\Side View\IPB 160
Steel Profiles\DIN 1025/2\Side View\IPB 180
Steel Profiles\DIN 1025/2\Side View\IPB 200
Steel Profiles\DIN 1025/2\Side View\IPB 220
Steel Profiles\DIN 1025/2\Side View\IPB 240
Steel Profiles\DIN 1025/2\Side View\IPB 260
Steel Profiles\DIN 1025/2\Side View\IPB 280
Steel Profiles\DIN 1025/2\Side View\IPB 300
Steel Profiles\DIN 1025/2\Side View\IPB 320
Steel Profiles\DIN 1025/2\Side View\IPB 340
Steel Profiles\DIN 1025/2\Side View\IPB 360
Steel Profiles\DIN 1025/2\Side View\IPB 400
Steel Profiles\DIN 1025/2\Side View\IPB 450
Steel Profiles\DIN 1025/2\Side View\IPB 500
Steel Profiles\DIN 1025/2\Side View\IPB 550
Steel Profiles\DIN 1025/2\Side View\IPB 600
Steel Profiles\DIN 1025/2\Side View\IPB 650
Steel Profiles\DIN 1025/2\Side View\IPB 1000
Steel Profiles\DIN 1025/2\Side View\IPB 900
Steel Profiles\DIN 1025/2\Side View\IPB 800
Steel Profiles\DIN 1025/2\Side View\IPB 700
Steel Profiles\DIN 1025/2\Normal View\IPB 100
Steel Profiles\DIN 1025/2\Normal View\IPB 120
Steel Profiles\DIN 1025/2\Normal View\IPB 140
Steel Profiles\DIN 1025/2\Normal View\IPB 160
Steel Profiles\DIN 1025/2\Normal View\IPB 180
Steel Profiles\DIN 1025/2\Normal View\IPB 200

Steel Profiles\DIN 1025/2\Normal View\IPB 220
Steel Profiles\DIN 1025/2\Normal View\IPB 240
Steel Profiles\DIN 1025/2\Normal View\IPB 260
Steel Profiles\DIN 1025/2\Normal View\IPB 280
Steel Profiles\DIN 1025/2\Normal View\IPB 300
Steel Profiles\DIN 1025/2\Normal View\IPB 320
Steel Profiles\DIN 1025/2\Normal View\IPB 340
Steel Profiles\DIN 1025/2\Normal View\IPB 360
Steel Profiles\DIN 1025/2\Normal View\IPB 400
Steel Profiles\DIN 1025/2\Normal View\IPB 450
Steel Profiles\DIN 1025/2\Normal View\IPB 500
Steel Profiles\DIN 1025/2\Normal View\IPB 550
Steel Profiles\DIN 1025/2\Normal View\IPB 600
Steel Profiles\DIN 1025/2\Normal View\IPB 650
Steel Profiles\DIN 1025/2\Normal View\IPB 700
Steel Profiles\DIN 1025/2\Normal View\IPB 800
Steel Profiles\DIN 1025/2\Normal View\IPB 900
Steel Profiles\DIN 1025/2\Normal View\IPB 1000
Steel Profiles\DIN 1025/2\Plan View\IPB 100
Steel Profiles\DIN 1025/2\Plan View\IPB 120
Steel Profiles\DIN 1025/2\Plan View\IPB 140
Steel Profiles\DIN 1025/2\Plan View\IPB 160
Steel Profiles\DIN 1025/2\Plan View\IPB 180
Steel Profiles\DIN 1025/2\Plan View\IPB 200
Steel Profiles\DIN 1025/2\Plan View\IPB 220
Steel Profiles\DIN 1025/2\Plan View\IPB 240
Steel Profiles\DIN 1025/2\Plan View\IPB 260
Steel Profiles\DIN 1025/2\Plan View\IPB 280
Steel Profiles\DIN 1025/2\Plan View\IPB 300
Steel Profiles\DIN 1025/2\Plan View\IPB 320
Steel Profiles\DIN 1025/2\Plan View\IPB 340
Steel Profiles\DIN 1025/2\Plan View\IPB 360
Steel Profiles\DIN 1025/2\Plan View\IPB 400
Steel Profiles\DIN 1025/2\Plan View\IPB 450
Steel Profiles\DIN 1025/2\Plan View\IPB 500
Steel Profiles\DIN 1025/2\Plan View\IPB 550
Steel Profiles\DIN 1025/2\Plan View\IPB 600
Steel Profiles\DIN 1025/2\Plan View\IPB 650
Steel Profiles\DIN 1025/2\Plan View\IPB 700
Steel Profiles\DIN 1025/2\Plan View\IPB 800
Steel Profiles\DIN 1025/2\Plan View\IPB 900
Steel Profiles\DIN 1025/2\Plan View\IPB 1000
Steel Profiles\DIN 1025/2\Side View\IB 100
Steel Profiles\DIN 1025/2\Side View\IB 120
Steel Profiles\DIN 1025/2\Side View\IB 140
Steel Profiles\DIN 1025/2\Side View\IB 160
Steel Profiles\DIN 1025/2\Side View\IB 180
Steel Profiles\DIN 1025/2\Normal View\IB 100
Steel Profiles\DIN 1025/2\Normal View\IB 120
Steel Profiles\DIN 1025/2\Normal View\IB 140
Steel Profiles\DIN 1025/2\Normal View\IB 160

Steel Profiles\DIN 1025/2\Normal View\IB 180
Steel Profiles\DIN 1025/2\Plan View\IB 100
Steel Profiles\DIN 1025/2\Plan View\IB 120
Steel Profiles\DIN 1025/2\Plan View\IB 140
Steel Profiles\DIN 1025/2\Plan View\IB 160
Steel Profiles\DIN 1025/2\Plan View\IB 180
Steel Profiles\DIN 1025/3\Side View\IPB 100
Steel Profiles\DIN 1025/3\Side View\IPB 120
Steel Profiles\DIN 1025/3\Side View\IPB 140
Steel Profiles\DIN 1025/3\Side View\IPB 160
Steel Profiles\DIN 1025/3\Side View\IPB 180
Steel Profiles\DIN 1025/3\Side View\IPB 200
Steel Profiles\DIN 1025/3\Side View\IPB 220
Steel Profiles\DIN 1025/3\Side View\IPB 240
Steel Profiles\DIN 1025/3\Side View\IPB 260
Steel Profiles\DIN 1025/3\Side View\IPB 280
Steel Profiles\DIN 1025/3\Side View\IPB 300
Steel Profiles\DIN 1025/3\Side View\IPB 320
Steel Profiles\DIN 1025/3\Side View\IPB 340
Steel Profiles\DIN 1025/3\Side View\IPB 360
Steel Profiles\DIN 1025/3\Side View\IPB 400
Steel Profiles\DIN 1025/3\Side View\IPB 450
Steel Profiles\DIN 1025/3\Side View\IPB 500
Steel Profiles\DIN 1025/3\Side View\IPB 550
Steel Profiles\DIN 1025/3\Side View\IPB 600
Steel Profiles\DIN 1025/3\Side View\IPB 650
Steel Profiles\DIN 1025/3\Side View\IPB 1000
Steel Profiles\DIN 1025/3\Side View\IPB 900
Steel Profiles\DIN 1025/3\Side View\IPB 800
Steel Profiles\DIN 1025/3\Side View\IPB 700
Steel Profiles\DIN 1025/3\Normal View\IPB 100
Steel Profiles\DIN 1025/3\Normal View\IPB 120
Steel Profiles\DIN 1025/3\Normal View\IPB 140
Steel Profiles\DIN 1025/3\Normal View\IPB 160
Steel Profiles\DIN 1025/3\Normal View\IPB 180
Steel Profiles\DIN 1025/3\Normal View\IPB 200
Steel Profiles\DIN 1025/3\Normal View\IPB 220
Steel Profiles\DIN 1025/3\Normal View\IPB 240
Steel Profiles\DIN 1025/3\Normal View\IPB 260
Steel Profiles\DIN 1025/3\Normal View\IPB 280
Steel Profiles\DIN 1025/3\Normal View\IPB 300
Steel Profiles\DIN 1025/3\Normal View\IPB 320
Steel Profiles\DIN 1025/3\Normal View\IPB 340
Steel Profiles\DIN 1025/3\Normal View\IPB 360
Steel Profiles\DIN 1025/3\Normal View\IPB 400
Steel Profiles\DIN 1025/3\Normal View\IPB 450
Steel Profiles\DIN 1025/3\Normal View\IPB 500
Steel Profiles\DIN 1025/3\Normal View\IPB 550
Steel Profiles\DIN 1025/3\Normal View\IPB 600
Steel Profiles\DIN 1025/3\Normal View\IPB 650
Steel Profiles\DIN 1025/3\Normal View\IPB 700

Steel Profiles\DIN 1025/3\Normal View\IPBI 800
Steel Profiles\DIN 1025/3\Normal View\IPBI 900
Steel Profiles\DIN 1025/3\Normal View\IPBI 1000
Steel Profiles\DIN 1025/3\Plan View\IPBI 100
Steel Profiles\DIN 1025/3\Plan View\IPBI 120
Steel Profiles\DIN 1025/3\Plan View\IPBI 140
Steel Profiles\DIN 1025/3\Plan View\IPBI 160
Steel Profiles\DIN 1025/3\Plan View\IPBI 180
Steel Profiles\DIN 1025/3\Plan View\IPBI 200
Steel Profiles\DIN 1025/3\Plan View\IPBI 220
Steel Profiles\DIN 1025/3\Plan View\IPBI 240
Steel Profiles\DIN 1025/3\Plan View\IPBI 260
Steel Profiles\DIN 1025/3\Plan View\IPBI 280
Steel Profiles\DIN 1025/3\Plan View\IPBI 300
Steel Profiles\DIN 1025/3\Plan View\IPBI 320
Steel Profiles\DIN 1025/3\Plan View\IPBI 340
Steel Profiles\DIN 1025/3\Plan View\IPBI 360
Steel Profiles\DIN 1025/3\Plan View\IPBI 400
Steel Profiles\DIN 1025/3\Plan View\IPBI 450
Steel Profiles\DIN 1025/3\Plan View\IPBI 500
Steel Profiles\DIN 1025/3\Plan View\IPBI 550
Steel Profiles\DIN 1025/3\Plan View\IPBI 600
Steel Profiles\DIN 1025/3\Plan View\IPBI 650
Steel Profiles\DIN 1025/3\Plan View\IPBI 700
Steel Profiles\DIN 1025/3\Plan View\IPBI 800
Steel Profiles\DIN 1025/3\Plan View\IPBI 900
Steel Profiles\DIN 1025/3\Plan View\IPBI 1000
Steel Profiles\DIN 1025/4\Side View\IPBv 100
Steel Profiles\DIN 1025/4\Side View\IPBv 120
Steel Profiles\DIN 1025/4\Side View\IPBv 140
Steel Profiles\DIN 1025/4\Side View\IPBv 160
Steel Profiles\DIN 1025/4\Side View\IPBv 180
Steel Profiles\DIN 1025/4\Side View\IPBv 200
Steel Profiles\DIN 1025/4\Side View\IPBv 220
Steel Profiles\DIN 1025/4\Side View\IPBv 240
Steel Profiles\DIN 1025/4\Side View\IPBv 260
Steel Profiles\DIN 1025/4\Side View\IPBv 280
Steel Profiles\DIN 1025/4\Side View\IPBv 300
Steel Profiles\DIN 1025/4\Side View\IPBv 305
Steel Profiles\DIN 1025/4\Side View\IPBv 320
Steel Profiles\DIN 1025/4\Side View\IPBv 340
Steel Profiles\DIN 1025/4\Side View\IPBv 360
Steel Profiles\DIN 1025/4\Side View\IPBv 400
Steel Profiles\DIN 1025/4\Side View\IPBv 450
Steel Profiles\DIN 1025/4\Side View\IPBv 500
Steel Profiles\DIN 1025/4\Side View\IPBv 550
Steel Profiles\DIN 1025/4\Side View\IPBv 600
Steel Profiles\DIN 1025/4\Side View\IPBv 650
Steel Profiles\DIN 1025/4\Side View\IPBv 700
Steel Profiles\DIN 1025/4\Side View\IPBv 800
Steel Profiles\DIN 1025/4\Side View\IPBv 900

Steel Profiles\DIN 1025/4\Side View\IPBv 1000
Steel Profiles\DIN 1025/4\Normal View\IPBv 100
Steel Profiles\DIN 1025/4\Normal View\IPBv 120
Steel Profiles\DIN 1025/4\Normal View\IPBv 140
Steel Profiles\DIN 1025/4\Normal View\IPBv 160
Steel Profiles\DIN 1025/4\Normal View\IPBv 180
Steel Profiles\DIN 1025/4\Normal View\IPBv 200
Steel Profiles\DIN 1025/4\Normal View\IPBv 220
Steel Profiles\DIN 1025/4\Normal View\IPBv 240
Steel Profiles\DIN 1025/4\Normal View\IPBv 260
Steel Profiles\DIN 1025/4\Normal View\IPBv 280
Steel Profiles\DIN 1025/4\Normal View\IPBv 300
Steel Profiles\DIN 1025/4\Normal View\IPBv 305
Steel Profiles\DIN 1025/4\Normal View\IPBv 320
Steel Profiles\DIN 1025/4\Normal View\IPBv 340
Steel Profiles\DIN 1025/4\Normal View\IPBv 360
Steel Profiles\DIN 1025/4\Normal View\IPBv 400
Steel Profiles\DIN 1025/4\Normal View\IPBv 450
Steel Profiles\DIN 1025/4\Normal View\IPBv 500
Steel Profiles\DIN 1025/4\Normal View\IPBv 550
Steel Profiles\DIN 1025/4\Normal View\IPBv 600
Steel Profiles\DIN 1025/4\Normal View\IPBv 650
Steel Profiles\DIN 1025/4\Normal View\IPBv 700
Steel Profiles\DIN 1025/4\Normal View\IPBv 800
Steel Profiles\DIN 1025/4\Normal View\IPBv 900
Steel Profiles\DIN 1025/4\Normal View\IPBv 1000
Steel Profiles\DIN 1025/4\Plan View\IPBv 1000
Steel Profiles\DIN 1025/4\Plan View\IPBv 900
Steel Profiles\DIN 1025/4\Plan View\IPBv 800
Steel Profiles\DIN 1025/4\Plan View\IPBv 700
Steel Profiles\DIN 1025/4\Plan View\IPBv 650
Steel Profiles\DIN 1025/4\Plan View\IPBv 600
Steel Profiles\DIN 1025/4\Plan View\IPBv 550
Steel Profiles\DIN 1025/4\Plan View\IPBv 500
Steel Profiles\DIN 1025/4\Plan View\IPBv 450
Steel Profiles\DIN 1025/4\Plan View\IPBv 400
Steel Profiles\DIN 1025/4\Plan View\IPBv 360
Steel Profiles\DIN 1025/4\Plan View\IPBv 340
Steel Profiles\DIN 1025/4\Plan View\IPBv 320
Steel Profiles\DIN 1025/4\Plan View\IPBv 305
Steel Profiles\DIN 1025/4\Plan View\IPBv 300
Steel Profiles\DIN 1025/4\Plan View\IPBv 280
Steel Profiles\DIN 1025/4\Plan View\IPBv 260
Steel Profiles\DIN 1025/4\Plan View\IPBv 240
Steel Profiles\DIN 1025/4\Plan View\IPBv 220
Steel Profiles\DIN 1025/4\Plan View\IPBv 200
Steel Profiles\DIN 1025/4\Plan View\IPBv 180
Steel Profiles\DIN 1025/4\Plan View\IPBv 160
Steel Profiles\DIN 1025/4\Plan View\IPBv 140
Steel Profiles\DIN 1025/4\Plan View\IPBv 120
Steel Profiles\DIN 1025/4\Plan View\IPBv 100

Steel Profiles\DIN 1025/5\Side View\IPE 80
Steel Profiles\DIN 1025/5\Side View\IPE 100
Steel Profiles\DIN 1025/5\Side View\IPE 120
Steel Profiles\DIN 1025/5\Side View\IPE 140
Steel Profiles\DIN 1025/5\Side View\IPE 160
Steel Profiles\DIN 1025/5\Side View\IPE 180
Steel Profiles\DIN 1025/5\Side View\IPE 200
Steel Profiles\DIN 1025/5\Side View\IPE 220
Steel Profiles\DIN 1025/5\Side View\IPE 240
Steel Profiles\DIN 1025/5\Side View\IPE 270
Steel Profiles\DIN 1025/5\Side View\IPE 300
Steel Profiles\DIN 1025/5\Side View\IPE 330
Steel Profiles\DIN 1025/5\Side View\IPE 360
Steel Profiles\DIN 1025/5\Side View\IPE 400
Steel Profiles\DIN 1025/5\Side View\IPE 450
Steel Profiles\DIN 1025/5\Side View\IPE 500
Steel Profiles\DIN 1025/5\Side View\IPE 550
Steel Profiles\DIN 1025/5\Side View\IPE 600
Steel Profiles\DIN 1025/5\Plan View\IPE 600
Steel Profiles\DIN 1025/5\Plan View\IPE 550
Steel Profiles\DIN 1025/5\Plan View\IPE 500
Steel Profiles\DIN 1025/5\Plan View\IPE 450
Steel Profiles\DIN 1025/5\Plan View\IPE 400
Steel Profiles\DIN 1025/5\Plan View\IPE 360
Steel Profiles\DIN 1025/5\Plan View\IPE 330
Steel Profiles\DIN 1025/5\Plan View\IPE 300
Steel Profiles\DIN 1025/5\Plan View\IPE 270
Steel Profiles\DIN 1025/5\Plan View\IPE 240
Steel Profiles\DIN 1025/5\Plan View\IPE 220
Steel Profiles\DIN 1025/5\Plan View\IPE 200
Steel Profiles\DIN 1025/5\Plan View\IPE 180
Steel Profiles\DIN 1025/5\Plan View\IPE 160
Steel Profiles\DIN 1025/5\Plan View\IPE 140
Steel Profiles\DIN 1025/5\Plan View\IPE 120
Steel Profiles\DIN 1025/5\Plan View\IPE 100
Steel Profiles\DIN 1025/5\Plan View\IPE 80
Steel Profiles\DIN 1025/5\Normal View\IPE 80
Steel Profiles\DIN 1025/5\Normal View\IPE 100
Steel Profiles\DIN 1025/5\Normal View\IPE 120
Steel Profiles\DIN 1025/5\Normal View\IPE 140
Steel Profiles\DIN 1025/5\Normal View\IPE 160
Steel Profiles\DIN 1025/5\Normal View\IPE 180
Steel Profiles\DIN 1025/5\Normal View\IPE 200
Steel Profiles\DIN 1025/5\Normal View\IPE 220
Steel Profiles\DIN 1025/5\Normal View\IPE 240
Steel Profiles\DIN 1025/5\Normal View\IPE 270
Steel Profiles\DIN 1025/5\Normal View\IPE 300
Steel Profiles\DIN 1025/5\Normal View\IPE 330
Steel Profiles\DIN 1025/5\Normal View\IPE 360
Steel Profiles\DIN 1025/5\Normal View\IPE 400
Steel Profiles\DIN 1025/5\Normal View\IPE 450

Steel Profiles\DIN 1025/5\Normal View\IPE 500
Steel Profiles\DIN 1025/5\Normal View\IPE 550
Steel Profiles\DIN 1025/5\Normal View\IPE 600
Steel Profiles\DIN 1026\Side View\U 30x15
Steel Profiles\DIN 1026\Side View\U 30
Steel Profiles\DIN 1026\Side View\U 40x20
Steel Profiles\DIN 1026\Side View\U 40
Steel Profiles\DIN 1026\Side View\U 200
Steel Profiles\DIN 1026\Side View\U 220
Steel Profiles\DIN 1026\Side View\U 240
Steel Profiles\DIN 1026\Side View\U 260
Steel Profiles\DIN 1026\Side View\U 280
Steel Profiles\DIN 1026\Side View\U 300
Steel Profiles\DIN 1026\Side View\U 320
Steel Profiles\DIN 1026\Side View\U 350
Steel Profiles\DIN 1026\Side View\U 380
Steel Profiles\DIN 1026\Side View\U 400
Steel Profiles\DIN 1026\Normal View\U 30x15
Steel Profiles\DIN 1026\Normal View\U 30
Steel Profiles\DIN 1026\Normal View\U 40x20
Steel Profiles\DIN 1026\Normal View\U 40
Steel Profiles\DIN 1026\Normal View\U 50x25
Steel Profiles\DIN 1026\Normal View\U 50
Steel Profiles\DIN 1026\Normal View\U 60
Steel Profiles\DIN 1026\Normal View\U 65
Steel Profiles\DIN 1026\Normal View\U 80
Steel Profiles\DIN 1026\Normal View\U 100
Steel Profiles\DIN 1026\Normal View\U 120
Steel Profiles\DIN 1026\Normal View\U 140
Steel Profiles\DIN 1026\Normal View\U 160
Steel Profiles\DIN 1026\Normal View\U 180
Steel Profiles\DIN 1026\Normal View\U 200
Steel Profiles\DIN 1026\Normal View\U 220
Steel Profiles\DIN 1026\Normal View\U 240
Steel Profiles\DIN 1026\Normal View\U 260
Steel Profiles\DIN 1026\Normal View\U 280
Steel Profiles\DIN 1026\Normal View\U 300
Steel Profiles\DIN 1026\Normal View\U 320
Steel Profiles\DIN 1026\Normal View\U 350
Steel Profiles\DIN 1026\Normal View\U 380
Steel Profiles\DIN 1026\Normal View\U 400
Steel Profiles\DIN 1026\Plan View\U 30x15
Steel Profiles\DIN 1026\Plan View\U 30
Steel Profiles\DIN 1026\Plan View\U 40x20
Steel Profiles\DIN 1026\Plan View\U 40
Steel Profiles\DIN 1026\Plan View\U 50x25
Steel Profiles\DIN 1026\Plan View\U 50
Steel Profiles\DIN 1026\Plan View\U 60
Steel Profiles\DIN 1026\Plan View\U 65
Steel Profiles\DIN 1026\Plan View\U 80
Steel Profiles\DIN 1026\Plan View\U 100

Steel Profiles\DIN 1026\Plan View\U 120
Steel Profiles\DIN 1026\Plan View\U 140
Steel Profiles\DIN 1026\Plan View\U 160
Steel Profiles\DIN 1026\Plan View\U 180
Steel Profiles\DIN 1026\Plan View\U 200
Steel Profiles\DIN 1026\Plan View\U 220
Steel Profiles\DIN 1026\Plan View\U 240
Steel Profiles\DIN 1026\Plan View\U 260
Steel Profiles\DIN 1026\Plan View\U 280
Steel Profiles\DIN 1026\Plan View\U 300
Steel Profiles\DIN 1026\Plan View\U 320
Steel Profiles\DIN 1026\Plan View\U 350
Steel Profiles\DIN 1026\Plan View\U 380
Steel Profiles\DIN 1026\Plan View\U 400
Steel Profiles\DIN 1026\Side View\U 50x25
Steel Profiles\DIN 1026\Side View\U 50
Steel Profiles\DIN 1026\Side View\U 60
Steel Profiles\DIN 1026\Side View\U 65
Steel Profiles\DIN 1026\Side View\U 80
Steel Profiles\DIN 1026\Side View\U 100
Steel Profiles\DIN 1026\Side View\U 120
Steel Profiles\DIN 1026\Side View\U 140
Steel Profiles\DIN 1026\Side View\U 160
Steel Profiles\DIN 1026\Side View\U 180
Steel Profiles\DIN 1027\Side View\Z 30
Steel Profiles\DIN 1027\Side View\Z 40
Steel Profiles\DIN 1027\Side View\Z 50
Steel Profiles\DIN 1027\Side View\Z 60
Steel Profiles\DIN 1027\Side View\Z 80
Steel Profiles\DIN 1027\Side View\Z 100
Steel Profiles\DIN 1027\Side View\Z 120
Steel Profiles\DIN 1027\Side View\Z 140
Steel Profiles\DIN 1027\Side View\Z 160
Steel Profiles\DIN 1027\Side View\Z 180
Steel Profiles\DIN 1027\Side View\Z 200
Steel Profiles\DIN 1027\Normal View\Z 30
Steel Profiles\DIN 1027\Normal View\Z 40
Steel Profiles\DIN 1027\Normal View\Z 50
Steel Profiles\DIN 1027\Normal View\Z 60
Steel Profiles\DIN 1027\Normal View\Z 80
Steel Profiles\DIN 1027\Normal View\Z 100
Steel Profiles\DIN 1027\Normal View\Z 120
Steel Profiles\DIN 1027\Normal View\Z 140
Steel Profiles\DIN 1027\Normal View\Z 160
Steel Profiles\DIN 1027\Normal View\Z 180
Steel Profiles\DIN 1027\Normal View\Z 200
Steel Profiles\DIN 1027\Plan View\Z 30
Steel Profiles\DIN 1027\Plan View\Z 40
Steel Profiles\DIN 1027\Plan View\Z 50
Steel Profiles\DIN 1027\Plan View\Z 60
Steel Profiles\DIN 1027\Plan View\Z 80

Steel Profiles\DIN 1027\Plan View\Z 100
Steel Profiles\DIN 1027\Plan View\Z 120
Steel Profiles\DIN 1027\Plan View\Z 140
Steel Profiles\DIN 1027\Plan View\Z 160
Steel Profiles\DIN 1027\Plan View\Z 180
Steel Profiles\DIN 1027\Plan View\Z 200
Steel Profiles\DIN 1028\Side View\L 20x3
Steel Profiles\DIN 1028\Side View\L 25x3
Steel Profiles\DIN 1028\Side View\L 25x4
Steel Profiles\DIN 1028\Side View\L 30x3
Steel Profiles\DIN 1028\Side View\L 30x4
Steel Profiles\DIN 1028\Side View\L 35x4
Steel Profiles\DIN 1028\Side View\L 35x5
Steel Profiles\DIN 1028\Side View\L 40x4
Steel Profiles\DIN 1028\Side View\L 40x5
Steel Profiles\DIN 1028\Side View\L 45x4
Steel Profiles\DIN 1028\Side View\L 45x5
Steel Profiles\DIN 1028\Side View\L 50x5
Steel Profiles\DIN 1028\Side View\L 50x6
Steel Profiles\DIN 1028\Side View\L 50x7
Steel Profiles\DIN 1028\Side View\L 60x5
Steel Profiles\DIN 1028\Side View\L 60x6
Steel Profiles\DIN 1028\Side View\L 60x8
Steel Profiles\DIN 1028\Side View\L 65x7
Steel Profiles\DIN 1028\Side View\L 70x7
Steel Profiles\DIN 1028\Side View\L 70x9
Steel Profiles\DIN 1028\Side View\L 75x7
Steel Profiles\DIN 1028\Side View\L 75x8
Steel Profiles\DIN 1028\Side View\L 80x6
Steel Profiles\DIN 1028\Side View\L 80x8
Steel Profiles\DIN 1028\Side View\L 80x10
Steel Profiles\DIN 1028\Side View\L 90x7
Steel Profiles\DIN 1028\Side View\L 90x9
Steel Profiles\DIN 1028\Side View\L 100x8
Steel Profiles\DIN 1028\Side View\L 100x10
Steel Profiles\DIN 1028\Side View\L 100x12
Steel Profiles\DIN 1028\Side View\L 110x10
Steel Profiles\DIN 1028\Side View\L 120x10
Steel Profiles\DIN 1028\Side View\L 120x12
Steel Profiles\DIN 1028\Side View\L 130x12
Steel Profiles\DIN 1028\Side View\L 140x13
Steel Profiles\DIN 1028\Side View\L 150x12
Steel Profiles\DIN 1028\Side View\L 150x15
Steel Profiles\DIN 1028\Side View\L 160x15
Steel Profiles\DIN 1028\Side View\L 180x16
Steel Profiles\DIN 1028\Side View\L 180x18
Steel Profiles\DIN 1028\Side View\L 200x16
Steel Profiles\DIN 1028\Side View\L 200x20
Steel Profiles\DIN 1028\Side View\L 200x24
Steel Profiles\DIN 1028\Normal View\L 20x3
Steel Profiles\DIN 1028\Normal View\L 25x3

Steel Profiles\DIN 1028\Normal View\L 25x4
Steel Profiles\DIN 1028\Normal View\L 30x3
Steel Profiles\DIN 1028\Normal View\L 30x4
Steel Profiles\DIN 1028\Normal View\L 35x4
Steel Profiles\DIN 1028\Normal View\L 35x5
Steel Profiles\DIN 1028\Normal View\L 40x4
Steel Profiles\DIN 1028\Normal View\L 40x5
Steel Profiles\DIN 1028\Normal View\L 45x4
Steel Profiles\DIN 1028\Normal View\L 45x5
Steel Profiles\DIN 1028\Normal View\L 50x5
Steel Profiles\DIN 1028\Normal View\L 50x6
Steel Profiles\DIN 1028\Normal View\L 50x7
Steel Profiles\DIN 1028\Normal View\L 60x5
Steel Profiles\DIN 1028\Normal View\L 60x6
Steel Profiles\DIN 1028\Normal View\L 60x8
Steel Profiles\DIN 1028\Normal View\L 65x7
Steel Profiles\DIN 1028\Normal View\L 70x7
Steel Profiles\DIN 1028\Normal View\L 70x9
Steel Profiles\DIN 1028\Normal View\L 75x7
Steel Profiles\DIN 1028\Normal View\L 75x8
Steel Profiles\DIN 1028\Normal View\L 80x6
Steel Profiles\DIN 1028\Normal View\L 80x8
Steel Profiles\DIN 1028\Normal View\L 80x10
Steel Profiles\DIN 1028\Normal View\L 90x7
Steel Profiles\DIN 1028\Normal View\L 90x9
Steel Profiles\DIN 1028\Normal View\L 100x8
Steel Profiles\DIN 1028\Normal View\L 100x10
Steel Profiles\DIN 1028\Normal View\L 100x12
Steel Profiles\DIN 1028\Normal View\L 110x10
Steel Profiles\DIN 1028\Normal View\L 120x10
Steel Profiles\DIN 1028\Normal View\L 120x12
Steel Profiles\DIN 1028\Normal View\L 130x12
Steel Profiles\DIN 1028\Normal View\L 140x13
Steel Profiles\DIN 1028\Normal View\L 150x12
Steel Profiles\DIN 1028\Normal View\L 150x15
Steel Profiles\DIN 1028\Normal View\L 160x15
Steel Profiles\DIN 1028\Normal View\L 180x16
Steel Profiles\DIN 1028\Normal View\L 180x18
Steel Profiles\DIN 1028\Normal View\L 200x16
Steel Profiles\DIN 1028\Normal View\L 200x20
Steel Profiles\DIN 1028\Normal View\L 200x24
Steel Profiles\DIN 1028\Plan View\U 20x3
Steel Profiles\DIN 1028\Plan View\U 25x3
Steel Profiles\DIN 1028\Plan View\U 25x4
Steel Profiles\DIN 1028\Plan View\U 30x3
Steel Profiles\DIN 1028\Plan View\U 30x4
Steel Profiles\DIN 1028\Plan View\U 35x4
Steel Profiles\DIN 1028\Plan View\U 35x5
Steel Profiles\DIN 1028\Plan View\U 40x4
Steel Profiles\DIN 1028\Plan View\U 40x5
Steel Profiles\DIN 1028\Plan View\U 45x4

Steel Profiles\DIN 1028\Plan View\U 45x5
Steel Profiles\DIN 1028\Plan View\U 50x5
Steel Profiles\DIN 1028\Plan View\U 50x6
Steel Profiles\DIN 1028\Plan View\U 50x7
Steel Profiles\DIN 1028\Plan View\U 60x5
Steel Profiles\DIN 1028\Plan View\U 60x6
Steel Profiles\DIN 1028\Plan View\U 60x8
Steel Profiles\DIN 1028\Plan View\U 65x7
Steel Profiles\DIN 1028\Plan View\U 70x7
Steel Profiles\DIN 1028\Plan View\U 70x9
Steel Profiles\DIN 1028\Plan View\U 75x7
Steel Profiles\DIN 1028\Plan View\U 75x8
Steel Profiles\DIN 1028\Plan View\U 80x6
Steel Profiles\DIN 1028\Plan View\U 80x8
Steel Profiles\DIN 1028\Plan View\U 80x10
Steel Profiles\DIN 1028\Plan View\U 90x7
Steel Profiles\DIN 1028\Plan View\U 90x9
Steel Profiles\DIN 1028\Plan View\U 100x8
Steel Profiles\DIN 1028\Plan View\U 100x10
Steel Profiles\DIN 1028\Plan View\U 100x12
Steel Profiles\DIN 1028\Plan View\U 110x10
Steel Profiles\DIN 1028\Plan View\U 120x10
Steel Profiles\DIN 1028\Plan View\U 120x12
Steel Profiles\DIN 1028\Plan View\U 130x12
Steel Profiles\DIN 1028\Plan View\U 140x13
Steel Profiles\DIN 1028\Plan View\U 150x12
Steel Profiles\DIN 1028\Plan View\U 150x15
Steel Profiles\DIN 1028\Plan View\U 160x15
Steel Profiles\DIN 1028\Plan View\U 180x16
Steel Profiles\DIN 1028\Plan View\U 180x18
Steel Profiles\DIN 1028\Plan View\U 200x16
Steel Profiles\DIN 1028\Plan View\U 200x20
Steel Profiles\DIN 1028\Plan View\U 200x24
Steel Profiles\DIN 1029\Side View\L 30x20x3
Steel Profiles\DIN 1029\Side View\L 30x20x4
Steel Profiles\DIN 1029\Side View\L 40x20x3
Steel Profiles\DIN 1029\Side View\L 40x20x4
Steel Profiles\DIN 1029\Side View\L 45x30x4
Steel Profiles\DIN 1029\Side View\L 45x30x5
Steel Profiles\DIN 1029\Side View\L 50x30x4
Steel Profiles\DIN 1029\Side View\L 50x30x5
Steel Profiles\DIN 1029\Side View\L 50x40x5
Steel Profiles\DIN 1029\Side View\L 60x30x5
Steel Profiles\DIN 1029\Side View\L 60x40x5
Steel Profiles\DIN 1029\Side View\L 60x40x6
Steel Profiles\DIN 1029\Side View\L 65x50x5
Steel Profiles\DIN 1029\Side View\L 70x50x6
Steel Profiles\DIN 1029\Side View\L 75x50x7
Steel Profiles\DIN 1029\Side View\L 75x55x5
Steel Profiles\DIN 1029\Side View\L 75x55x7
Steel Profiles\DIN 1029\Side View\L 80x40x6

Steel Profiles\DIN 1029\Side View\L 80x40x8
Steel Profiles\DIN 1029\Side View\L 80x60x7
Steel Profiles\DIN 1029\Side View\L 80x65x8
Steel Profiles\DIN 1029\Side View\L 90x60x6
Steel Profiles\DIN 1029\Side View\L 90x60x8
Steel Profiles\DIN 1029\Side View\L 100x50x6
Steel Profiles\DIN 1029\Side View\L 100x50x8
Steel Profiles\DIN 1029\Side View\L 100x50x10
Steel Profiles\DIN 1029\Side View\L 100x65x7
Steel Profiles\DIN 1029\Side View\L 100x65x9
Steel Profiles\DIN 1029\Side View\L 100x75x9
Steel Profiles\DIN 1029\Side View\L 120x80x8
Steel Profiles\DIN 1029\Side View\L 120x80x10
Steel Profiles\DIN 1029\Side View\L 120x80x12
Steel Profiles\DIN 1029\Side View\L 130x65x8
Steel Profiles\DIN 1029\Side View\L 130x65x10
Steel Profiles\DIN 1029\Side View\L 150x75x9
Steel Profiles\DIN 1029\Side View\L 150x75x11
Steel Profiles\DIN 1029\Side View\L 150x100x10
Steel Profiles\DIN 1029\Side View\L 150x100x12
Steel Profiles\DIN 1029\Side View\L 180x90x10
Steel Profiles\DIN 1029\Side View\L 200x100x10
Steel Profiles\DIN 1029\Side View\L 200x100x12
Steel Profiles\DIN 1029\Side View\L 200x100x14
Steel Profiles\DIN 1029\Normal View\L 30x20x3
Steel Profiles\DIN 1029\Normal View\L 30x20x4
Steel Profiles\DIN 1029\Normal View\L 40x20x3
Steel Profiles\DIN 1029\Normal View\L 40x20x4
Steel Profiles\DIN 1029\Normal View\L 45x30x4
Steel Profiles\DIN 1029\Normal View\L 45x30x5
Steel Profiles\DIN 1029\Normal View\L 50x30x4
Steel Profiles\DIN 1029\Normal View\L 50x30x5
Steel Profiles\DIN 1029\Normal View\L 50x40x5
Steel Profiles\DIN 1029\Normal View\L 60x30x5
Steel Profiles\DIN 1029\Normal View\L 60x40x5
Steel Profiles\DIN 1029\Normal View\L 60x40x6
Steel Profiles\DIN 1029\Normal View\L 65x50x5
Steel Profiles\DIN 1029\Normal View\L 70x50x6
Steel Profiles\DIN 1029\Normal View\L 75x50x7
Steel Profiles\DIN 1029\Normal View\L 75x55x5
Steel Profiles\DIN 1029\Normal View\L 75x55x7
Steel Profiles\DIN 1029\Normal View\L 80x40x6
Steel Profiles\DIN 1029\Normal View\L 80x40x8
Steel Profiles\DIN 1029\Normal View\L 80x60x7
Steel Profiles\DIN 1029\Normal View\L 80x65x8
Steel Profiles\DIN 1029\Normal View\L 90x60x6
Steel Profiles\DIN 1029\Normal View\L 90x60x8
Steel Profiles\DIN 1029\Normal View\L 100x50x6
Steel Profiles\DIN 1029\Normal View\L 100x50x8
Steel Profiles\DIN 1029\Normal View\L 100x50x10
Steel Profiles\DIN 1029\Normal View\L 100x65x7

Steel Profiles\DIN 1029\Normal View\L 100x65x9
Steel Profiles\DIN 1029\Normal View\L 100x75x9
Steel Profiles\DIN 1029\Normal View\L 120x80x8
Steel Profiles\DIN 1029\Normal View\L 120x80x10
Steel Profiles\DIN 1029\Normal View\L 120x80x12
Steel Profiles\DIN 1029\Normal View\L 130x65x8
Steel Profiles\DIN 1029\Normal View\L 130x65x10
Steel Profiles\DIN 1029\Normal View\L 150x75x9
Steel Profiles\DIN 1029\Normal View\L 150x75x11
Steel Profiles\DIN 1029\Normal View\L 150x100x10
Steel Profiles\DIN 1029\Normal View\L 150x100x12
Steel Profiles\DIN 1029\Normal View\L 180x90x10
Steel Profiles\DIN 1029\Normal View\L 200x100x10
Steel Profiles\DIN 1029\Normal View\L 200x100x12
Steel Profiles\DIN 1029\Normal View\L 200x100x14
Steel Profiles\DIN 1029\Plan View\L 30x20x3
Steel Profiles\DIN 1029\Plan View\L 30x20x4
Steel Profiles\DIN 1029\Plan View\L 40x20x3
Steel Profiles\DIN 1029\Plan View\L 40x20x4
Steel Profiles\DIN 1029\Plan View\L 45x30x4
Steel Profiles\DIN 1029\Plan View\L 45x30x5
Steel Profiles\DIN 1029\Plan View\L 50x30x4
Steel Profiles\DIN 1029\Plan View\L 50x30x5
Steel Profiles\DIN 1029\Plan View\L 50x40x5
Steel Profiles\DIN 1029\Plan View\L 60x30x5
Steel Profiles\DIN 1029\Plan View\L 60x40x5
Steel Profiles\DIN 1029\Plan View\L 60x40x6
Steel Profiles\DIN 1029\Plan View\L 65x50x5
Steel Profiles\DIN 1029\Plan View\L 70x50x6
Steel Profiles\DIN 1029\Plan View\L 75x50x7
Steel Profiles\DIN 1029\Plan View\L 75x55x5
Steel Profiles\DIN 1029\Plan View\L 75x55x7
Steel Profiles\DIN 1029\Plan View\L 80x40x6
Steel Profiles\DIN 1029\Plan View\L 80x40x8
Steel Profiles\DIN 1029\Plan View\L 80x60x7
Steel Profiles\DIN 1029\Plan View\L 80x65x8
Steel Profiles\DIN 1029\Plan View\L 90x60x6
Steel Profiles\DIN 1029\Plan View\L 90x60x8
Steel Profiles\DIN 1029\Plan View\L 100x50x6
Steel Profiles\DIN 1029\Plan View\L 100x50x8
Steel Profiles\DIN 1029\Plan View\L 100x50x10
Steel Profiles\DIN 1029\Plan View\L 100x65x7
Steel Profiles\DIN 1029\Plan View\L 100x65x9
Steel Profiles\DIN 1029\Plan View\L 100x75x9
Steel Profiles\DIN 1029\Plan View\L 120x80x8
Steel Profiles\DIN 1029\Plan View\L 120x80x10
Steel Profiles\DIN 1029\Plan View\L 120x80x12
Steel Profiles\DIN 1029\Plan View\L 130x65x8
Steel Profiles\DIN 1029\Plan View\L 130x65x10
Steel Profiles\DIN 1029\Plan View\L 150x75x9
Steel Profiles\DIN 1029\Plan View\L 150x75x11

Steel Profiles\DIN 1029\Plan View\L 150x100x10
Steel Profiles\DIN 1029\Plan View\L 150x100x12
Steel Profiles\DIN 1029\Plan View\L 180x90x10
Steel Profiles\DIN 1029\Plan View\L 200x100x10
Steel Profiles\DIN 1029\Plan View\L 200x100x12
Steel Profiles\DIN 1029\Plan View\L 200x100x14
Alloy Profiles\DIN 1771\Side View shard-edged\L 10
Alloy Profiles\DIN 1771\Side View shard-edged\L 10x10x1.5
Alloy Profiles\DIN 1771\Side View shard-edged\L 10x10x2
Alloy Profiles\DIN 1771\Side View shard-edged\L 10x10x2.5
Alloy Profiles\DIN 1771\Side View shard-edged\L 15x10x2
Alloy Profiles\DIN 1771\Side View shard-edged\L 15x15x1.5
Alloy Profiles\DIN 1771\Side View shard-edged\L 15x15x2
Alloy Profiles\DIN 1771\Side View shard-edged\L 15x15x2.5
Alloy Profiles\DIN 1771\Side View shard-edged\L 15x15x3
Alloy Profiles\DIN 1771\Side View shard-edged\L 20x10x1.5
Alloy Profiles\DIN 1771\Side View shard-edged\L 20x10x2
Alloy Profiles\DIN 1771\Side View shard-edged\L 20x10x2.5
Alloy Profiles\DIN 1771\Side View shard-edged\L 20x15x1.5
Alloy Profiles\DIN 1771\Side View shard-edged\L 20x15x2
Alloy Profiles\DIN 1771\Side View shard-edged\L 20x15x2.5
Alloy Profiles\DIN 1771\Side View shard-edged\L 20x20x2
Alloy Profiles\DIN 1771\Side View shard-edged\L 20x20x2.5
Alloy Profiles\DIN 1771\Side View shard-edged\L 20x20x3
Alloy Profiles\DIN 1771\Side View shard-edged\L 25x10x2
Alloy Profiles\DIN 1771\Side View shard-edged\L 25x10x3
Alloy Profiles\DIN 1771\Side View shard-edged\L 25x15x2
Alloy Profiles\DIN 1771\Side View shard-edged\L 25x15x3
Alloy Profiles\DIN 1771\Side View shard-edged\L 25x20x2.5
Alloy Profiles\DIN 1771\Side View shard-edged\L 25x25x2
Alloy Profiles\DIN 1771\Side View shard-edged\L 25x25x2.5
Alloy Profiles\DIN 1771\Side View shard-edged\L 25x25x3
Alloy Profiles\DIN 1771\Side View shard-edged\L 30x15x2
Alloy Profiles\DIN 1771\Side View shard-edged\L 30x15x2.5
Alloy Profiles\DIN 1771\Side View shard-edged\L 30x15x3
Alloy Profiles\DIN 1771\Side View shard-edged\L 30x20x2
Alloy Profiles\DIN 1771\Side View shard-edged\L 30x20x2.5
Alloy Profiles\DIN 1771\Side View shard-edged\L 30x20x3
Alloy Profiles\DIN 1771\Side View shard-edged\L 30x20x4
Alloy Profiles\DIN 1771\Side View shard-edged\L 30x30x2.5
Alloy Profiles\DIN 1771\Side View shard-edged\L 30x30x3
Alloy Profiles\DIN 1771\Side View shard-edged\L 30x30x4
Alloy Profiles\DIN 1771\Side View shard-edged\L 30x30x5
Alloy Profiles\DIN 1771\Side View shard-edged\L 35x35x2.5
Alloy Profiles\DIN 1771\Side View shard-edged\L 35x35x3
Alloy Profiles\DIN 1771\Side View shard-edged\L 35x35x4
Alloy Profiles\DIN 1771\Side View shard-edged\L 35x35x5
Alloy Profiles\DIN 1771\Side View rounded\L 10x10x1.5
Alloy Profiles\DIN 1771\Side View rounded\L 10x10x2
Alloy Profiles\DIN 1771\Side View rounded\L 10x10x2.5
Alloy Profiles\DIN 1771\Side View rounded\L 15x10x2

Alloy Profiles\DIN 1771\Side View rounded\L 15x15x1.5
Alloy Profiles\DIN 1771\Side View rounded\L 15x15x2
Alloy Profiles\DIN 1771\Side View rounded\L 15x15x2.5
Alloy Profiles\DIN 1771\Side View rounded\L 15x15x3
Alloy Profiles\DIN 1771\Side View rounded\L 20x10x1.5
Alloy Profiles\DIN 1771\Side View rounded\L 20x10x2
Alloy Profiles\DIN 1771\Side View rounded\L 20x10x2.5
Alloy Profiles\DIN 1771\Side View rounded\L 20x15x1.5
Alloy Profiles\DIN 1771\Side View rounded\L 20x15x2
Alloy Profiles\DIN 1771\Side View rounded\L 20x15x2.5
Alloy Profiles\DIN 1771\Side View rounded\L 20x20x2
Alloy Profiles\DIN 1771\Side View rounded\L 20x20x2.5
Alloy Profiles\DIN 1771\Side View rounded\L 20x20x3
Alloy Profiles\DIN 1771\Side View rounded\L 25x10x2
Alloy Profiles\DIN 1771\Side View rounded\L 25x10x3
Alloy Profiles\DIN 1771\Side View rounded\L 25x15x2
Alloy Profiles\DIN 1771\Side View rounded\L 25x15x3
Alloy Profiles\DIN 1771\Side View rounded\L 25x20x2.5
Alloy Profiles\DIN 1771\Side View rounded\L 25x25x2
Alloy Profiles\DIN 1771\Side View rounded\L 25x25x2.5
Alloy Profiles\DIN 1771\Side View rounded\L 25x25x3
Alloy Profiles\DIN 1771\Side View rounded\L 30x15x2
Alloy Profiles\DIN 1771\Side View rounded\L 30x15x2.5
Alloy Profiles\DIN 1771\Side View rounded\L 30x15x3
Alloy Profiles\DIN 1771\Side View rounded\L 30x20x2
Alloy Profiles\DIN 1771\Side View rounded\L 30x20x2.5
Alloy Profiles\DIN 1771\Side View rounded\L 30x20x3
Alloy Profiles\DIN 1771\Side View rounded\L 30x20x4
Alloy Profiles\DIN 1771\Side View rounded\L 30x30x2.5
Alloy Profiles\DIN 1771\Side View rounded\L 30x30x3
Alloy Profiles\DIN 1771\Side View rounded\L 30x30x4
Alloy Profiles\DIN 1771\Side View rounded\L 30x30x5
Alloy Profiles\DIN 1771\Side View rounded\L 35x35x2.5
Alloy Profiles\DIN 1771\Side View rounded\L 35x35x3
Alloy Profiles\DIN 1771\Side View rounded\L 35x35x4
Alloy Profiles\DIN 1771\Side View rounded\L 35x35x5
Alloy Profiles\DIN 1771\Normal View\L 10x10x1.5
Alloy Profiles\DIN 1771\Normal View\L 10x10x2
Alloy Profiles\DIN 1771\Normal View\L 10x10x2.5
Alloy Profiles\DIN 1771\Normal View\L 15x10x2
Alloy Profiles\DIN 1771\Normal View\L 15x15x1.5
Alloy Profiles\DIN 1771\Normal View\L 15x15x2
Alloy Profiles\DIN 1771\Normal View\L 15x15x2.5
Alloy Profiles\DIN 1771\Normal View\L 15x15x3
Alloy Profiles\DIN 1771\Normal View\L 20x10x1.5
Alloy Profiles\DIN 1771\Normal View\L 20x10x2
Alloy Profiles\DIN 1771\Normal View\L 20x10x2.5
Alloy Profiles\DIN 1771\Normal View\L 20x15x1.5
Alloy Profiles\DIN 1771\Normal View\L 20x15x2
Alloy Profiles\DIN 1771\Normal View\L 20x15x2.5
Alloy Profiles\DIN 1771\Normal View\L 20x20x2

Alloy Profiles\DIN 1771\Normal View\L 20x20x2.5
Alloy Profiles\DIN 1771\Normal View\L 20x20x3
Alloy Profiles\DIN 1771\Normal View\L 25x10x2
Alloy Profiles\DIN 1771\Normal View\L 25x10x3
Alloy Profiles\DIN 1771\Normal View\L 25x15x2
Alloy Profiles\DIN 1771\Normal View\L 25x15x3
Alloy Profiles\DIN 1771\Normal View\L 25x20x2.5
Alloy Profiles\DIN 1771\Normal View\L 25x25x2
Alloy Profiles\DIN 1771\Normal View\L 25x25x2.5
Alloy Profiles\DIN 1771\Normal View\L 25x25x3
Alloy Profiles\DIN 1771\Normal View\L 30x15x2
Alloy Profiles\DIN 1771\Normal View\L 30x15x2.5
Alloy Profiles\DIN 1771\Normal View\L 30x15x3
Alloy Profiles\DIN 1771\Normal View\L 30x20x2
Alloy Profiles\DIN 1771\Normal View\L 30x20x2.5
Alloy Profiles\DIN 1771\Normal View\L 30x20x3
Alloy Profiles\DIN 1771\Normal View\L 30x20x4
Alloy Profiles\DIN 1771\Normal View\L 30x30x2.5
Alloy Profiles\DIN 1771\Normal View\L 30x30x3
Alloy Profiles\DIN 1771\Normal View\L 30x30x4
Alloy Profiles\DIN 1771\Normal View\L 30x30x5
Alloy Profiles\DIN 1771\Normal View\L 35x35x2.5
Alloy Profiles\DIN 1771\Normal View\L 35x35x3
Alloy Profiles\DIN 1771\Normal View\L 35x35x4
Alloy Profiles\DIN 1771\Normal View\L 35x35x5
Alloy Profiles\DIN 1771\Plan View\L 10x10x1.5
Alloy Profiles\DIN 1771\Plan View\L 10x10x2
Alloy Profiles\DIN 1771\Plan View\L 10x10x2.5
Alloy Profiles\DIN 1771\Plan View\L 15x10x2
Alloy Profiles\DIN 1771\Plan View\L 15x15x1.5
Alloy Profiles\DIN 1771\Plan View\L 15x15x2
Alloy Profiles\DIN 1771\Plan View\L 15x15x2.5
Alloy Profiles\DIN 1771\Plan View\L 15x15x3
Alloy Profiles\DIN 1771\Plan View\L 20x10x1.5
Alloy Profiles\DIN 1771\Plan View\L 20x10x2
Alloy Profiles\DIN 1771\Plan View\L 20x10x2.5
Alloy Profiles\DIN 1771\Plan View\L 20x15x1.5
Alloy Profiles\DIN 1771\Plan View\L 20x15x2
Alloy Profiles\DIN 1771\Plan View\L 20x15x2.5
Alloy Profiles\DIN 1771\Plan View\L 20x20x2
Alloy Profiles\DIN 1771\Plan View\L 20x20x2.5
Alloy Profiles\DIN 1771\Plan View\L 20x20x3
Alloy Profiles\DIN 1771\Plan View\L 25x10x2
Alloy Profiles\DIN 1771\Plan View\L 25x10x3
Alloy Profiles\DIN 1771\Plan View\L 25x15x2
Alloy Profiles\DIN 1771\Plan View\L 25x15x3
Alloy Profiles\DIN 1771\Plan View\L 25x20x2.5
Alloy Profiles\DIN 1771\Plan View\L 25x25x2
Alloy Profiles\DIN 1771\Plan View\L 25x25x2.5
Alloy Profiles\DIN 1771\Plan View\L 25x25x3
Alloy Profiles\DIN 1771\Plan View\L 30x15x2

Alloy Profiles\DIN 1771\Plan View\L 30x15x2.5
Alloy Profiles\DIN 1771\Plan View\L 30x15x3
Alloy Profiles\DIN 1771\Plan View\L 30x20x2
Alloy Profiles\DIN 1771\Plan View\L 30x20x2.5
Alloy Profiles\DIN 1771\Plan View\L 30x20x3
Alloy Profiles\DIN 1771\Plan View\L 30x20x4
Alloy Profiles\DIN 1771\Plan View\L 30x30x2.5
Alloy Profiles\DIN 1771\Plan View\L 30x30x3
Alloy Profiles\DIN 1771\Plan View\L 30x30x4
Alloy Profiles\DIN 1771\Plan View\L 30x30x5
Alloy Profiles\DIN 1771\Plan View\L 35x35x2.5
Alloy Profiles\DIN 1771\Plan View\L 35x35x3
Alloy Profiles\DIN 1771\Plan View\L 35x35x4
Alloy Profiles\DIN 1771\Plan View\L 35x35x5
Alloy Profiles\DIN 1771\Side View shard-edged\L 40x20x2
Alloy Profiles\DIN 1771\Side View shard-edged\L 40x20x2.5
Alloy Profiles\DIN 1771\Side View shard-edged\L 40x20x3
Alloy Profiles\DIN 1771\Side View shard-edged\L 40x20x4
Alloy Profiles\DIN 1771\Side View shard-edged\L 40x25x2.5
Alloy Profiles\DIN 1771\Side View shard-edged\L 40x25x3
Alloy Profiles\DIN 1771\Side View shard-edged\L 40x25x4
Alloy Profiles\DIN 1771\Side View shard-edged\L 40x30x5
Alloy Profiles\DIN 1771\Side View shard-edged\L 40x40x3
Alloy Profiles\DIN 1771\Side View shard-edged\L 40x40x4
Alloy Profiles\DIN 1771\Side View shard-edged\L 40x40x5
Alloy Profiles\DIN 1771\Side View shard-edged\L 50x25x2.5
Alloy Profiles\DIN 1771\Side View shard-edged\L 50x25x3
Alloy Profiles\DIN 1771\Side View shard-edged\L 50x25x4
Alloy Profiles\DIN 1771\Side View shard-edged\L 50x30x3
Alloy Profiles\DIN 1771\Side View shard-edged\L 50x30x4
Alloy Profiles\DIN 1771\Side View shard-edged\L 50x30x5
Alloy Profiles\DIN 1771\Side View shard-edged\L 50x50x3
Alloy Profiles\DIN 1771\Side View shard-edged\L 50x50x4
Alloy Profiles\DIN 1771\Side View shard-edged\L 50x50x5
Alloy Profiles\DIN 1771\Side View shard-edged\L 50x50x6
Alloy Profiles\DIN 1771\Side View shard-edged\L 60x30x3
Alloy Profiles\DIN 1771\Side View shard-edged\L 60x30x4
Alloy Profiles\DIN 1771\Side View shard-edged\L 60x30x5
Alloy Profiles\DIN 1771\Side View shard-edged\L 60x40x4
Alloy Profiles\DIN 1771\Side View shard-edged\L 60x40x5
Alloy Profiles\DIN 1771\Side View shard-edged\L 60x40x6
Alloy Profiles\DIN 1771\Side View shard-edged\L 60x60x4
Alloy Profiles\DIN 1771\Side View shard-edged\L 60x60x5
Alloy Profiles\DIN 1771\Side View shard-edged\L 60x60x6
Alloy Profiles\DIN 1771\Side View shard-edged\L 65x25x3
Alloy Profiles\DIN 1771\Side View shard-edged\L 65x50x5
Alloy Profiles\DIN 1771\Side View shard-edged\L 65x50x6
Alloy Profiles\DIN 1771\Side View shard-edged\L 65x50x7
Alloy Profiles\DIN 1771\Side View shard-edged\L 80x40x4
Alloy Profiles\DIN 1771\Side View shard-edged\L 80x40x5
Alloy Profiles\DIN 1771\Side View shard-edged\L 80x40x6

Alloy Profiles\DIN 1771\Side View shard-edged\L 80x80x8
Alloy Profiles\DIN 1771\Side View shard-edged\L 80x80x10
Alloy Profiles\DIN 1771\Side View shard-edged\L 80x80x12
Alloy Profiles\DIN 1771\Side View rounded\L 40x20x2
Alloy Profiles\DIN 1771\Side View rounded\L 40x20x2.5
Alloy Profiles\DIN 1771\Side View rounded\L 40x20x3
Alloy Profiles\DIN 1771\Side View rounded\L 40x20x4
Alloy Profiles\DIN 1771\Side View rounded\L 40x25x2.5
Alloy Profiles\DIN 1771\Side View rounded\L 40x25x3
Alloy Profiles\DIN 1771\Side View rounded\L 40x25x4
Alloy Profiles\DIN 1771\Side View rounded\L 40x30x5
Alloy Profiles\DIN 1771\Side View rounded\L 40x40x3
Alloy Profiles\DIN 1771\Side View rounded\L 40x40x4
Alloy Profiles\DIN 1771\Side View rounded\L 40x40x5
Alloy Profiles\DIN 1771\Side View rounded\L 50x25x2.5
Alloy Profiles\DIN 1771\Side View rounded\L 50x25x3
Alloy Profiles\DIN 1771\Side View rounded\L 50x25x4
Alloy Profiles\DIN 1771\Side View rounded\L 50x30x3
Alloy Profiles\DIN 1771\Side View rounded\L 50x30x4
Alloy Profiles\DIN 1771\Side View rounded\L 50x30x5
Alloy Profiles\DIN 1771\Side View rounded\L 50x50x3
Alloy Profiles\DIN 1771\Side View rounded\L 50x50x4
Alloy Profiles\DIN 1771\Side View rounded\L 50x50x5
Alloy Profiles\DIN 1771\Side View rounded\L 50x50x6
Alloy Profiles\DIN 1771\Side View rounded\L 60x30x3
Alloy Profiles\DIN 1771\Side View rounded\L 60x30x4
Alloy Profiles\DIN 1771\Side View rounded\L 60x30x5
Alloy Profiles\DIN 1771\Side View rounded\L 60x40x4
Alloy Profiles\DIN 1771\Side View rounded\L 60x40x5
Alloy Profiles\DIN 1771\Side View rounded\L 60x40x6
Alloy Profiles\DIN 1771\Side View rounded\L 60x60x4
Alloy Profiles\DIN 1771\Side View rounded\L 60x60x5
Alloy Profiles\DIN 1771\Side View rounded\L 60x60x6
Alloy Profiles\DIN 1771\Side View rounded\L 60x25x3
Alloy Profiles\DIN 1771\Side View rounded\L 65x50x5
Alloy Profiles\DIN 1771\Side View rounded\L 65x50x6
Alloy Profiles\DIN 1771\Side View rounded\L 65x50x7
Alloy Profiles\DIN 1771\Side View rounded\L 80x40x4
Alloy Profiles\DIN 1771\Side View rounded\L 80x40x5
Alloy Profiles\DIN 1771\Side View rounded\L 80x40x6
Alloy Profiles\DIN 1771\Side View rounded\L 80x80x8
Alloy Profiles\DIN 1771\Side View rounded\L 80x80x10
Alloy Profiles\DIN 1771\Side View rounded\L 80x80x12
Alloy Profiles\DIN 1771\Normal View\L 40x20x2
Alloy Profiles\DIN 1771\Normal View\L 40x20x2.5
Alloy Profiles\DIN 1771\Normal View\L 40x20x3
Alloy Profiles\DIN 1771\Normal View\L 40x20x4
Alloy Profiles\DIN 1771\Normal View\L 40x25x2.5
Alloy Profiles\DIN 1771\Normal View\L 40x25x3
Alloy Profiles\DIN 1771\Normal View\L 40x25x4
Alloy Profiles\DIN 1771\Normal View\L 40x30x5

Alloy Profiles\DIN 1771\Normal View\L 40x40x3
Alloy Profiles\DIN 1771\Normal View\L 40x40x4
Alloy Profiles\DIN 1771\Normal View\L 40x40x5
Alloy Profiles\DIN 1771\Normal View\L 50x25x2.5
Alloy Profiles\DIN 1771\Normal View\L 50x25x3
Alloy Profiles\DIN 1771\Normal View\L 50x25x4
Alloy Profiles\DIN 1771\Normal View\L 50x30x3
Alloy Profiles\DIN 1771\Normal View\L 50x30x4
Alloy Profiles\DIN 1771\Normal View\L 50x30x5
Alloy Profiles\DIN 1771\Normal View\L 50x50x3
Alloy Profiles\DIN 1771\Normal View\L 50x50x4
Alloy Profiles\DIN 1771\Normal View\L 50x50x5
Alloy Profiles\DIN 1771\Normal View\L 50x50x6
Alloy Profiles\DIN 1771\Normal View\L 60x30x3
Alloy Profiles\DIN 1771\Normal View\L 60x30x4
Alloy Profiles\DIN 1771\Normal View\L 60x30x5
Alloy Profiles\DIN 1771\Normal View\L 60x40x4
Alloy Profiles\DIN 1771\Normal View\L 60x40x5
Alloy Profiles\DIN 1771\Normal View\L 60x40x6
Alloy Profiles\DIN 1771\Normal View\L 60x60x4
Alloy Profiles\DIN 1771\Normal View\L 60x60x5
Alloy Profiles\DIN 1771\Normal View\L 60x60x6
Alloy Profiles\DIN 1771\Normal View\L 65x25x3
Alloy Profiles\DIN 1771\Normal View\L 65x50x5
Alloy Profiles\DIN 1771\Normal View\L 65x50x6
Alloy Profiles\DIN 1771\Normal View\L 65x50x7
Alloy Profiles\DIN 1771\Normal View\L 80x40x4
Alloy Profiles\DIN 1771\Normal View\L 80x40x5
Alloy Profiles\DIN 1771\Normal View\L 80x40x6
Alloy Profiles\DIN 1771\Normal View\L 80x80x8
Alloy Profiles\DIN 1771\Normal View\L 80x80x10
Alloy Profiles\DIN 1771\Normal View\L 80x80x12
Alloy Profiles\DIN 1771\Plan View\L 40x20x2
Alloy Profiles\DIN 1771\Plan View\L 40x20x2.5
Alloy Profiles\DIN 1771\Plan View\L 40x20x3
Alloy Profiles\DIN 1771\Plan View\L 40x20x4
Alloy Profiles\DIN 1771\Plan View\L 40x25x2.5
Alloy Profiles\DIN 1771\Plan View\L 40x25x3
Alloy Profiles\DIN 1771\Plan View\L 40x25x4
Alloy Profiles\DIN 1771\Plan View\L 40x30x5
Alloy Profiles\DIN 1771\Plan View\L 40x40x3
Alloy Profiles\DIN 1771\Plan View\L 40x40x4
Alloy Profiles\DIN 1771\Plan View\L 40x40x5
Alloy Profiles\DIN 1771\Plan View\L 50x25x2.5
Alloy Profiles\DIN 1771\Plan View\L 50x25x3
Alloy Profiles\DIN 1771\Plan View\L 50x25x4
Alloy Profiles\DIN 1771\Plan View\L 50x30x3
Alloy Profiles\DIN 1771\Plan View\L 50x30x4
Alloy Profiles\DIN 1771\Plan View\L 50x30x5
Alloy Profiles\DIN 1771\Plan View\L 50x50x3
Alloy Profiles\DIN 1771\Plan View\L 50x50x4

Alloy Profiles\DIN 1771\Plan View\L 50x50x5
Alloy Profiles\DIN 1771\Plan View\L 50x50x6
Alloy Profiles\DIN 1771\Plan View\L 60x30x3
Alloy Profiles\DIN 1771\Plan View\L 60x30x4
Alloy Profiles\DIN 1771\Plan View\L 60x30x5
Alloy Profiles\DIN 1771\Plan View\L 60x40x4
Alloy Profiles\DIN 1771\Plan View\L 60x40x5
Alloy Profiles\DIN 1771\Plan View\L 60x40x6
Alloy Profiles\DIN 1771\Plan View\L 60x60x4
Alloy Profiles\DIN 1771\Plan View\L 60x60x5
Alloy Profiles\DIN 1771\Plan View\L 60x60x6
Alloy Profiles\DIN 1771\Plan View\L 65x25x3
Alloy Profiles\DIN 1771\Plan View\L 65x50x5
Alloy Profiles\DIN 1771\Plan View\L 65x50x6
Alloy Profiles\DIN 1771\Plan View\L 65x50x7
Alloy Profiles\DIN 1771\Plan View\L 80x40x4
Alloy Profiles\DIN 1771\Plan View\L 80x40x5
Alloy Profiles\DIN 1771\Plan View\L 80x40x6
Alloy Profiles\DIN 1771\Plan View\L 80x80x8
Alloy Profiles\DIN 1771\Plan View\L 80x80x10
Alloy Profiles\DIN 1771\Plan View\L 80x80x12
Alloy Profiles\DIN 9712\Side View shard-edged\I 40x40x3x3
Alloy Profiles\DIN 9712\Side View shard-edged\I 40x40x4x4
Alloy Profiles\DIN 9712\Side View shard-edged\I 45x45x3x3
Alloy Profiles\DIN 9712\Side View shard-edged\I 45x45x4x4
Alloy Profiles\DIN 9712\Side View shard-edged\I 45x45x4x5
Alloy Profiles\DIN 9712\Side View shard-edged\I 50x50x3x3
Alloy Profiles\DIN 9712\Side View shard-edged\I 50x50x4x4
Alloy Profiles\DIN 9712\Side View shard-edged\I 50x50x4x6
Alloy Profiles\DIN 9712\Side View shard-edged\I 60x50x3x3
Alloy Profiles\DIN 9712\Side View shard-edged\I 60x50x4x4
Alloy Profiles\DIN 9712\Side View shard-edged\I 60x60x4x4
Alloy Profiles\DIN 9712\Side View shard-edged\I 60x60x4x6
Alloy Profiles\DIN 9712\Side View shard-edged\I 80x42x4x6
Alloy Profiles\DIN 9712\Side View shard-edged\I 80x60x5x6
Alloy Profiles\DIN 9712\Side View shard-edged\I 100x50x5x7
Alloy Profiles\DIN 9712\Side View shard-edged\I 100x70x6x7
Alloy Profiles\DIN 9712\Side View shard-edged\I 120x58x5x8
Alloy Profiles\DIN 9712\Side View shard-edged\I 120x80x7x9
Alloy Profiles\DIN 9712\Side View shard-edged\I 140x66x6x9
Alloy Profiles\DIN 9712\Side View shard-edged\I 140x90x8x10
Alloy Profiles\DIN 9712\Side View shard-edged\I 160x74x7x10
Alloy Profiles\DIN 9712\Side View shard-edged\I 180x82x7x10
Alloy Profiles\DIN 9712\Side View shard-edged\I 200x90x8x11
Alloy Profiles\DIN 9712\Side View rounded\I 40x40x3x3
Alloy Profiles\DIN 9712\Side View rounded\I 40x40x4x4
Alloy Profiles\DIN 9712\Side View rounded\I 45x45x3x3
Alloy Profiles\DIN 9712\Side View rounded\I 45x45x4x4
Alloy Profiles\DIN 9712\Side View rounded\I 45x45x4x5
Alloy Profiles\DIN 9712\Side View rounded\I 50x50x3x3
Alloy Profiles\DIN 9712\Side View rounded\I 50x50x4x4

Alloy Profiles\DIN 9712\Side View rounded\I 50x50x4x6
Alloy Profiles\DIN 9712\Side View rounded\I 60x50x3x3
Alloy Profiles\DIN 9712\Side View rounded\I 60x50x4x4
Alloy Profiles\DIN 9712\Side View rounded\I 60x60x4x4
Alloy Profiles\DIN 9712\Side View rounded\I 60x60x4x6
Alloy Profiles\DIN 9712\Side View rounded\I 80x42x4x6
Alloy Profiles\DIN 9712\Side View rounded\I 80x60x5x6
Alloy Profiles\DIN 9712\Side View rounded\I 100x50x5x7
Alloy Profiles\DIN 9712\Side View rounded\I 100x70x6x7
Alloy Profiles\DIN 9712\Side View rounded\I 120x58x5x8
Alloy Profiles\DIN 9712\Side View rounded\I 120x80x7x9
Alloy Profiles\DIN 9712\Side View rounded\I 140x66x6x9
Alloy Profiles\DIN 9712\Side View rounded\I 140x90x8x10
Alloy Profiles\DIN 9712\Side View rounded\I 160x74x7x10
Alloy Profiles\DIN 9712\Side View rounded\I 180x82x7x10
Alloy Profiles\DIN 9712\Side View rounded\I 200x90x8x11
Alloy Profiles\DIN 9712\Normal View\I 40x40x3x3
Alloy Profiles\DIN 9712\Normal View\I 40x40x4x4
Alloy Profiles\DIN 9712\Normal View\I 45x45x3x3
Alloy Profiles\DIN 9712\Normal View\I 45x45x4x4
Alloy Profiles\DIN 9712\Normal View\I 45x45x4x5
Alloy Profiles\DIN 9712\Normal View\I 50x50x3x3
Alloy Profiles\DIN 9712\Normal View\I 50x50x4x4
Alloy Profiles\DIN 9712\Normal View\I 50x50x4x6
Alloy Profiles\DIN 9712\Normal View\I 60x50x3x3
Alloy Profiles\DIN 9712\Normal View\I 60x50x4x4
Alloy Profiles\DIN 9712\Normal View\I 60x60x4x4
Alloy Profiles\DIN 9712\Normal View\I 60x60x4x6
Alloy Profiles\DIN 9712\Normal View\I 80x42x4x6
Alloy Profiles\DIN 9712\Normal View\I 80x60x5x6
Alloy Profiles\DIN 9712\Normal View\I 100x50x5x7
Alloy Profiles\DIN 9712\Normal View\I 100x70x6x7
Alloy Profiles\DIN 9712\Normal View\I 120x58x5x8
Alloy Profiles\DIN 9712\Normal View\I 120x80x7x9
Alloy Profiles\DIN 9712\Normal View\I 140x66x6x9
Alloy Profiles\DIN 9712\Normal View\I 140x90x8x10
Alloy Profiles\DIN 9712\Normal View\I 160x74x7x10
Alloy Profiles\DIN 9712\Normal View\I 180x82x7x10
Alloy Profiles\DIN 9712\Normal View\I 200x90x8x11
Alloy Profiles\DIN 9712\Plan View\I 40x40x3x3
Alloy Profiles\DIN 9712\Plan View\I 40x40x4x4
Alloy Profiles\DIN 9712\Plan View\I 45x45x3x3
Alloy Profiles\DIN 9712\Plan View\I 45x45x4x4
Alloy Profiles\DIN 9712\Plan View\I 45x45x4x5
Alloy Profiles\DIN 9712\Plan View\I 50x50x3x3
Alloy Profiles\DIN 9712\Plan View\I 50x50x4x4
Alloy Profiles\DIN 9712\Plan View\I 50x50x4x6
Alloy Profiles\DIN 9712\Plan View\I 60x50x3x3
Alloy Profiles\DIN 9712\Plan View\I 60x50x4x4
Alloy Profiles\DIN 9712\Plan View\I 60x60x4x4
Alloy Profiles\DIN 9712\Plan View\I 60x60x4x6

Alloy Profiles\DIN 9712\Plan View\I 80x42x4x6
Alloy Profiles\DIN 9712\Plan View\I 80x60x5x6
Alloy Profiles\DIN 9712\Plan View\I 100x50x5x7
Alloy Profiles\DIN 9712\Plan View\I 100x70x6x7
Alloy Profiles\DIN 9712\Plan View\I 120x58x5x8
Alloy Profiles\DIN 9712\Plan View\I 120x80x7x9
Alloy Profiles\DIN 9712\Plan View\I 140x66x6x9
Alloy Profiles\DIN 9712\Plan View\I 140x90x8x10
Alloy Profiles\DIN 9712\Plan View\I 160x74x7x10
Alloy Profiles\DIN 9712\Plan View\I 180x82x7x10
Alloy Profiles\DIN 9712\Plan View\I 200x90x8x11
Alloy Profiles\DIN 9713\Side View shard-edged\U 20x20x3x3
Alloy Profiles\DIN 9713\Side View shard-edged\U 30x30x3x3
Alloy Profiles\DIN 9713\Side View shard-edged\U 35x20x2x2
Alloy Profiles\DIN 9713\Side View shard-edged\U 35x35x3x3
Alloy Profiles\DIN 9713\Side View shard-edged\U 40x15x3x3
Alloy Profiles\DIN 9713\Side View shard-edged\U 40x20x2x2
Alloy Profiles\DIN 9713\Side View shard-edged\U 40x20x3x3
Alloy Profiles\DIN 9713\Side View shard-edged\U 40x30x3x3
Alloy Profiles\DIN 9713\Side View shard-edged\U 40x30x4x4
Alloy Profiles\DIN 9713\Side View shard-edged\U 40x40x4x4
Alloy Profiles\DIN 9713\Side View shard-edged\U 40x40x5x5
Alloy Profiles\DIN 9713\Side View shard-edged\U 50x20x2.5
Alloy Profiles\DIN 9713\Side View shard-edged\U 50x30x3x3
Alloy Profiles\DIN 9713\Side View shard-edged\U 50x30x4x4
Alloy Profiles\DIN 9713\Side View shard-edged\U 50x40x4x4
Alloy Profiles\DIN 9713\Side View shard-edged\U 50x40x5x5
Alloy Profiles\DIN 9713\Side View shard-edged\U 60x30x4x4
Alloy Profiles\DIN 9713\Side View shard-edged\U 60x30x5x5
Alloy Profiles\DIN 9713\Side View shard-edged\U 60x40x4x4
Alloy Profiles\DIN 9713\Side View shard-edged\U 60x40x5x5
Alloy Profiles\DIN 9713\Side View shard-edged\U 80x40x6x6
Alloy Profiles\DIN 9713\Side View shard-edged\U 80x45x6x8
Alloy Profiles\DIN 9713\Side View shard-edged\U 100x40x6x6
Alloy Profiles\DIN 9713\Side View shard-edged\U 100x50x6x9
Alloy Profiles\DIN 9713\Side View shard-edged\U 120x55x7x9
Alloy Profiles\DIN 9713\Side View shard-edged\U 140x60x4x6
Alloy Profiles\DIN 9713\Side View shard-edged\U 140x60x7x10
Alloy Profiles\DIN 9713\Side View rounded\U 20x20x3x3
Alloy Profiles\DIN 9713\Side View rounded\U 30x30x3x3
Alloy Profiles\DIN 9713\Side View rounded\U 35x20x2x2
Alloy Profiles\DIN 9713\Side View rounded\U 35x35x3x3
Alloy Profiles\DIN 9713\Side View rounded\U 40x15x3x3
Alloy Profiles\DIN 9713\Side View rounded\U 40x20x2x2
Alloy Profiles\DIN 9713\Side View rounded\U 40x20x3x3
Alloy Profiles\DIN 9713\Side View rounded\U 40x30x3x3
Alloy Profiles\DIN 9713\Side View rounded\U 40x30x4x4
Alloy Profiles\DIN 9713\Side View rounded\U 40x40x4x4
Alloy Profiles\DIN 9713\Side View rounded\U 40x40x5x5
Alloy Profiles\DIN 9713\Side View rounded\U 50x20x2.5
Alloy Profiles\DIN 9713\Side View rounded\U 50x30x3x3

Alloy Profiles\DIN 9713\Side View rounded\U 50x30x4x4
Alloy Profiles\DIN 9713\Side View rounded\U 50x40x4x4
Alloy Profiles\DIN 9713\Side View rounded\U 50x40x5x5
Alloy Profiles\DIN 9713\Side View rounded\U 60x30x4x4
Alloy Profiles\DIN 9713\Side View rounded\U 60x30x5x5
Alloy Profiles\DIN 9713\Side View rounded\U 60x40x4x4
Alloy Profiles\DIN 9713\Side View rounded\U 60x40x5x5
Alloy Profiles\DIN 9713\Side View rounded\U 80x40x6x6
Alloy Profiles\DIN 9713\Side View rounded\U 80x45x6x8
Alloy Profiles\DIN 9713\Side View rounded\U 100x40x6x6
Alloy Profiles\DIN 9713\Side View rounded\U 100x50x6x9
Alloy Profiles\DIN 9713\Side View rounded\U 120x55x7x9
Alloy Profiles\DIN 9713\Side View rounded\U 140x60x4x6
Alloy Profiles\DIN 9713\Side View rounded\U 140x60x7x10
Alloy Profiles\DIN 9713\Normal View\U 20x20x3x3
Alloy Profiles\DIN 9713\Normal View\U 30x30x3x3
Alloy Profiles\DIN 9713\Normal View\U 35x20x2x2
Alloy Profiles\DIN 9713\Normal View\U 35x35x3x3
Alloy Profiles\DIN 9713\Normal View\U 40x15x3x3
Alloy Profiles\DIN 9713\Normal View\U 40x20x2x2
Alloy Profiles\DIN 9713\Normal View\U 40x20x3x3
Alloy Profiles\DIN 9713\Normal View\U 40x30x3x3
Alloy Profiles\DIN 9713\Normal View\U 40x30x4x4
Alloy Profiles\DIN 9713\Normal View\U 40x40x4x4
Alloy Profiles\DIN 9713\Normal View\U 40x40x5x5
Alloy Profiles\DIN 9713\Normal View\U 50x20x2.5
Alloy Profiles\DIN 9713\Normal View\U 50x30x3x3
Alloy Profiles\DIN 9713\Normal View\U 50x30x4x4
Alloy Profiles\DIN 9713\Normal View\U 50x40x4x4
Alloy Profiles\DIN 9713\Normal View\U 50x40x5x5
Alloy Profiles\DIN 9713\Normal View\U 60x30x4x4
Alloy Profiles\DIN 9713\Normal View\U 60x30x5x5
Alloy Profiles\DIN 9713\Normal View\U 60x40x4x4
Alloy Profiles\DIN 9713\Normal View\U 60x40x5x5
Alloy Profiles\DIN 9713\Normal View\U 80x40x6x6
Alloy Profiles\DIN 9713\Normal View\U 80x45x6x8
Alloy Profiles\DIN 9713\Normal View\U 100x40x6x6
Alloy Profiles\DIN 9713\Normal View\U 100x50x6x9
Alloy Profiles\DIN 9713\Normal View\U 120x55x7x9
Alloy Profiles\DIN 9713\Normal View\U 140x60x4x6
Alloy Profiles\DIN 9713\Normal View\U 140x60x7x10
Alloy Profiles\DIN 9713\Plan View\U 20x20x3x3
Alloy Profiles\DIN 9713\Plan View\U 30x30x3x3
Alloy Profiles\DIN 9713\Plan View\U 35x20x2x2
Alloy Profiles\DIN 9713\Plan View\U 35x35x3x3
Alloy Profiles\DIN 9713\Plan View\U 40x15x3x3
Alloy Profiles\DIN 9713\Plan View\U 40x20x2x2
Alloy Profiles\DIN 9713\Plan View\U 40x20x3x3
Alloy Profiles\DIN 9713\Plan View\U 40x30x3x3
Alloy Profiles\DIN 9713\Plan View\U 40x30x4x4
Alloy Profiles\DIN 9713\Plan View\U 40x40x4x4

Alloy Profiles\DIN 9713\Plan View\U 40x40x5x5
Alloy Profiles\DIN 9713\Plan View\U 50x20x2.5
Alloy Profiles\DIN 9713\Plan View\U 50x30x3x3
Alloy Profiles\DIN 9713\Plan View\U 50x30x4x4
Alloy Profiles\DIN 9713\Plan View\U 50x40x4x4
Alloy Profiles\DIN 9713\Plan View\U 50x40x5x5
Alloy Profiles\DIN 9713\Plan View\U 60x30x4x4
Alloy Profiles\DIN 9713\Plan View\U 60x30x5x5
Alloy Profiles\DIN 9713\Plan View\U 60x40x4x4
Alloy Profiles\DIN 9713\Plan View\U 60x40x5x5
Alloy Profiles\DIN 9713\Plan View\U 80x40x6x6
Alloy Profiles\DIN 9713\Plan View\U 80x45x6x8
Alloy Profiles\DIN 9713\Plan View\U 100x40x6x6
Alloy Profiles\DIN 9713\Plan View\U 100x50x6x9
Alloy Profiles\DIN 9713\Plan View\U 120x55x7x9
Alloy Profiles\DIN 9713\Plan View\U 140x60x4x6
Alloy Profiles\DIN 9713\Plan View\U 140x60x7x10
Alloy Profiles\DIN 9714\Side View shard-edged\T 15x15x2
Alloy Profiles\DIN 9714\Side View shard-edged\T 20x20x2
Alloy Profiles\DIN 9714\Side View shard-edged\T 20x30x2
Alloy Profiles\DIN 9714\Side View shard-edged\T 20x30x2.5
Alloy Profiles\DIN 9714\Side View shard-edged\T 20x30x3
Alloy Profiles\DIN 9714\Side View shard-edged\T 25x25x2.5
Alloy Profiles\DIN 9714\Side View shard-edged\T 25x40x2
Alloy Profiles\DIN 9714\Side View shard-edged\T 25x40x2.5
Alloy Profiles\DIN 9714\Side View shard-edged\T 25x40x3
Alloy Profiles\DIN 9714\Side View shard-edged\T 30x30x2
Alloy Profiles\DIN 9714\Side View shard-edged\T 30x30x2.5
Alloy Profiles\DIN 9714\Side View shard-edged\T 30x30x3
Alloy Profiles\DIN 9714\Side View shard-edged\T 30x30x4
Alloy Profiles\DIN 9714\Side View shard-edged\T 30x45x2.5
Alloy Profiles\DIN 9714\Side View shard-edged\T 30x45x3
Alloy Profiles\DIN 9714\Side View shard-edged\T 30x45x4
Alloy Profiles\DIN 9714\Side View shard-edged\T 30x60x3
Alloy Profiles\DIN 9714\Side View shard-edged\T 30x60x5
Alloy Profiles\DIN 9714\Side View shard-edged\T 35x35x2.5
Alloy Profiles\DIN 9714\Side View shard-edged\T 35x35x3
Alloy Profiles\DIN 9714\Side View shard-edged\T 35x35x4
Alloy Profiles\DIN 9714\Side View shard-edged\T 35x50x3
Alloy Profiles\DIN 9714\Side View shard-edged\T 35x50x4
Alloy Profiles\DIN 9714\Side View shard-edged\T 35x50x5
Alloy Profiles\DIN 9714\Side View shard-edged\T 40x40x3
Alloy Profiles\DIN 9714\Side View shard-edged\T 40x40x4
Alloy Profiles\DIN 9714\Side View shard-edged\T 40x40x5
Alloy Profiles\DIN 9714\Side View shard-edged\T 40x60x4
Alloy Profiles\DIN 9714\Side View shard-edged\T 40x60x5
Alloy Profiles\DIN 9714\Side View shard-edged\T 40x80x5
Alloy Profiles\DIN 9714\Side View shard-edged\T 40x80x7
Alloy Profiles\DIN 9714\Side View shard-edged\T 50x50x3
Alloy Profiles\DIN 9714\Side View shard-edged\T 50x50x4
Alloy Profiles\DIN 9714\Side View shard-edged\T 50x50x5

Alloy Profiles\DIN 9714\Side View shard-edged\T 50x50x6
Alloy Profiles\DIN 9714\Side View shard-edged\T 50x70x4
Alloy Profiles\DIN 9714\Side View shard-edged\T 50x70x5
Alloy Profiles\DIN 9714\Side View shard-edged\T 50x70x6
Alloy Profiles\DIN 9714\Side View shard-edged\T 50x100x7
Alloy Profiles\DIN 9714\Side View shard-edged\T 50x100x9
Alloy Profiles\DIN 9714\Side View shard-edged\T 60x60x4
Alloy Profiles\DIN 9714\Side View shard-edged\T 60x60x5
Alloy Profiles\DIN 9714\Side View shard-edged\T 60x60x6
Alloy Profiles\DIN 9714\Side View shard-edged\T 60x60x7
Alloy Profiles\DIN 9714\Side View shard-edged\T 60x120x8
Alloy Profiles\DIN 9714\Side View shard-edged\T 60x120x10
Alloy Profiles\DIN 9714\Side View shard-edged\T 70x70x6
Alloy Profiles\DIN 9714\Side View shard-edged\T 70x70x8
Alloy Profiles\DIN 9714\Side View shard-edged\T 70x140x10
Alloy Profiles\DIN 9714\Side View shard-edged\T 70x140x12
Alloy Profiles\DIN 9714\Side View shard-edged\T 80x80x7
Alloy Profiles\DIN 9714\Side View shard-edged\T 80x80x9
Alloy Profiles\DIN 9714\Side View rounded\T 15x15x2
Alloy Profiles\DIN 9714\Side View rounded\T 20x20x2
Alloy Profiles\DIN 9714\Side View rounded\T 20x30x2
Alloy Profiles\DIN 9714\Side View rounded\T 20x30x2.5
Alloy Profiles\DIN 9714\Side View rounded\T 20x30x3
Alloy Profiles\DIN 9714\Side View rounded\T 25x25x2.5
Alloy Profiles\DIN 9714\Side View rounded\T 25x40x2
Alloy Profiles\DIN 9714\Side View rounded\T 25x40x2.5
Alloy Profiles\DIN 9714\Side View rounded\T 25x40x3
Alloy Profiles\DIN 9714\Side View rounded\T 30x30x2
Alloy Profiles\DIN 9714\Side View rounded\T 30x30x2.5
Alloy Profiles\DIN 9714\Side View rounded\T 30x30x3
Alloy Profiles\DIN 9714\Side View rounded\T 30x30x4
Alloy Profiles\DIN 9714\Side View rounded\T 30x45x2.5
Alloy Profiles\DIN 9714\Side View rounded\T 30x45x3
Alloy Profiles\DIN 9714\Side View rounded\T 30x45x4
Alloy Profiles\DIN 9714\Side View rounded\T 30x60x3
Alloy Profiles\DIN 9714\Side View rounded\T 30x60x5
Alloy Profiles\DIN 9714\Side View rounded\T 35x35x2.5
Alloy Profiles\DIN 9714\Side View rounded\T 35x35x3
Alloy Profiles\DIN 9714\Side View rounded\T 35x35x4
Alloy Profiles\DIN 9714\Side View rounded\T 35x50x3
Alloy Profiles\DIN 9714\Side View rounded\T 35x50x4
Alloy Profiles\DIN 9714\Side View rounded\T 35x50x5
Alloy Profiles\DIN 9714\Side View rounded\T 40x40x3
Alloy Profiles\DIN 9714\Side View rounded\T 40x40x4
Alloy Profiles\DIN 9714\Side View rounded\T 40x40x5
Alloy Profiles\DIN 9714\Side View rounded\T 40x60x4
Alloy Profiles\DIN 9714\Side View rounded\T 40x60x5
Alloy Profiles\DIN 9714\Side View rounded\T 40x80x5
Alloy Profiles\DIN 9714\Side View rounded\T 40x80x7
Alloy Profiles\DIN 9714\Side View rounded\T 50x50x3
Alloy Profiles\DIN 9714\Side View rounded\T 50x50x4

Alloy Profiles\DIN 9714\Side View rounded\T 50x50x5
Alloy Profiles\DIN 9714\Side View rounded\T 50x50x6
Alloy Profiles\DIN 9714\Side View rounded\T 50x70x4
Alloy Profiles\DIN 9714\Side View rounded\T 50x70x5
Alloy Profiles\DIN 9714\Side View rounded\T 50x70x6
Alloy Profiles\DIN 9714\Side View rounded\T 50x100x7
Alloy Profiles\DIN 9714\Side View rounded\T 50x100x9
Alloy Profiles\DIN 9714\Side View rounded\T 60x60x4
Alloy Profiles\DIN 9714\Side View rounded\T 60x60x5
Alloy Profiles\DIN 9714\Side View rounded\T 60x60x6
Alloy Profiles\DIN 9714\Side View rounded\T 60x60x7
Alloy Profiles\DIN 9714\Side View rounded\T 60x120x8
Alloy Profiles\DIN 9714\Side View rounded\T 60x120x10
Alloy Profiles\DIN 9714\Side View rounded\T 70x70x6
Alloy Profiles\DIN 9714\Side View rounded\T 70x70x8
Alloy Profiles\DIN 9714\Side View rounded\T 70x140x8
Alloy Profiles\DIN 9714\Side View rounded\T 70x140x10
Alloy Profiles\DIN 9714\Side View rounded\T 80x80x7
Alloy Profiles\DIN 9714\Side View rounded\T 80x80x9
Alloy Profiles\DIN 9714\Normal View\T 15x15x2
Alloy Profiles\DIN 9714\Normal View\T 20x20x2
Alloy Profiles\DIN 9714\Normal View\T 20x30x2
Alloy Profiles\DIN 9714\Normal View\T 20x30x2.5
Alloy Profiles\DIN 9714\Normal View\T 20x30x3
Alloy Profiles\DIN 9714\Normal View\T 25x25x2.5
Alloy Profiles\DIN 9714\Normal View\T 25x40x2
Alloy Profiles\DIN 9714\Normal View\T 25x40x2.5
Alloy Profiles\DIN 9714\Normal View\T 25x40x3
Alloy Profiles\DIN 9714\Normal View\T 30x30x2
Alloy Profiles\DIN 9714\Normal View\T 30x30x2.5
Alloy Profiles\DIN 9714\Normal View\T 30x30x3
Alloy Profiles\DIN 9714\Normal View\T 30x30x4
Alloy Profiles\DIN 9714\Normal View\T 30x45x2.5
Alloy Profiles\DIN 9714\Normal View\T 30x45x3
Alloy Profiles\DIN 9714\Normal View\T 30x45x4
Alloy Profiles\DIN 9714\Normal View\T 30x60x3
Alloy Profiles\DIN 9714\Normal View\T 30x60x5
Alloy Profiles\DIN 9714\Normal View\T 35x35x2.5
Alloy Profiles\DIN 9714\Normal View\T 35x35x3
Alloy Profiles\DIN 9714\Normal View\T 35x35x4
Alloy Profiles\DIN 9714\Normal View\T 35x50x3
Alloy Profiles\DIN 9714\Normal View\T 35x50x4
Alloy Profiles\DIN 9714\Normal View\T 35x50x5
Alloy Profiles\DIN 9714\Normal View\T 40x40x3
Alloy Profiles\DIN 9714\Normal View\T 40x40x4
Alloy Profiles\DIN 9714\Normal View\T 40x40x5
Alloy Profiles\DIN 9714\Normal View\T 40x60x4
Alloy Profiles\DIN 9714\Normal View\T 40x60x5
Alloy Profiles\DIN 9714\Normal View\T 40x80x5
Alloy Profiles\DIN 9714\Normal View\T 40x80x7
Alloy Profiles\DIN 9714\Normal View\T 50x50x3

Alloy Profiles\DIN 9714\Normal View\T 50x50x4
Alloy Profiles\DIN 9714\Normal View\T 50x50x5
Alloy Profiles\DIN 9714\Normal View\T 50x50x6
Alloy Profiles\DIN 9714\Normal View\T 50x70x4
Alloy Profiles\DIN 9714\Normal View\T 50x70x5
Alloy Profiles\DIN 9714\Normal View\T 50x70x6
Alloy Profiles\DIN 9714\Normal View\T 50x100x7
Alloy Profiles\DIN 9714\Normal View\T 50x100x9
Alloy Profiles\DIN 9714\Normal View\T 60x60x4
Alloy Profiles\DIN 9714\Normal View\T 60x60x5
Alloy Profiles\DIN 9714\Normal View\T 60x60x6
Alloy Profiles\DIN 9714\Normal View\T 60x60x7
Alloy Profiles\DIN 9714\Normal View\T 60x120x8
Alloy Profiles\DIN 9714\Normal View\T 60x120x10
Alloy Profiles\DIN 9714\Normal View\T 70x70x6
Alloy Profiles\DIN 9714\Normal View\T 70x70x8
Alloy Profiles\DIN 9714\Normal View\T 70x140x10
Alloy Profiles\DIN 9714\Normal View\T 70x140x12
Alloy Profiles\DIN 9714\Normal View\T 80x80x7
Alloy Profiles\DIN 9714\Normal View\T 80x80x9
Alloy Profiles\DIN 9714\Plan View\T 15x15x2
Alloy Profiles\DIN 9714\Plan View\T 20x20x2
Alloy Profiles\DIN 9714\Plan View\T 20x30x2
Alloy Profiles\DIN 9714\Plan View\T 20x30x2.5
Alloy Profiles\DIN 9714\Plan View\T 20x30x3
Alloy Profiles\DIN 9714\Plan View\T 25x25x2.5
Alloy Profiles\DIN 9714\Plan View\T 25x40x2
Alloy Profiles\DIN 9714\Plan View\T 25x40x2.5
Alloy Profiles\DIN 9714\Plan View\T 25x40x3
Alloy Profiles\DIN 9714\Plan View\T 30x30x2
Alloy Profiles\DIN 9714\Plan View\T 30x30x2.5
Alloy Profiles\DIN 9714\Plan View\T 30x30x3
Alloy Profiles\DIN 9714\Plan View\T 30x30x4
Alloy Profiles\DIN 9714\Plan View\T 30x45x2.5
Alloy Profiles\DIN 9714\Plan View\T 30x45x3
Alloy Profiles\DIN 9714\Plan View\T 30x45x4
Alloy Profiles\DIN 9714\Plan View\T 30x60x3
Alloy Profiles\DIN 9714\Plan View\T 30x60x5
Alloy Profiles\DIN 9714\Plan View\T 35x35x2.5
Alloy Profiles\DIN 9714\Plan View\T 35x35x3
Alloy Profiles\DIN 9714\Plan View\T 35x35x4
Alloy Profiles\DIN 9714\Plan View\T 35x50x3
Alloy Profiles\DIN 9714\Plan View\T 35x50x4
Alloy Profiles\DIN 9714\Plan View\T 35x50x5
Alloy Profiles\DIN 9714\Plan View\T 40x40x3
Alloy Profiles\DIN 9714\Plan View\T 40x40x4
Alloy Profiles\DIN 9714\Plan View\T 40x40x5
Alloy Profiles\DIN 9714\Plan View\T 40x60x4
Alloy Profiles\DIN 9714\Plan View\T 40x60x5
Alloy Profiles\DIN 9714\Plan View\T 40x80x5
Alloy Profiles\DIN 9714\Plan View\T 40x80x7

Alloy Profiles\DIN 9714\Plan View\T 50x50x3
Alloy Profiles\DIN 9714\Plan View\T 50x50x4
Alloy Profiles\DIN 9714\Plan View\T 50x50x5
Alloy Profiles\DIN 9714\Plan View\T 50x50x6
Alloy Profiles\DIN 9714\Plan View\T 50x70x4
Alloy Profiles\DIN 9714\Plan View\T 50x70x5
Alloy Profiles\DIN 9714\Plan View\T 50x70x6
Alloy Profiles\DIN 9714\Plan View\T 50x100x7
Alloy Profiles\DIN 9714\Plan View\T 50x100x9
Alloy Profiles\DIN 9714\Plan View\T 60x60x4
Alloy Profiles\DIN 9714\Plan View\T 60x60x5
Alloy Profiles\DIN 9714\Plan View\T 60x60x6
Alloy Profiles\DIN 9714\Plan View\T 60x60x7
Alloy Profiles\DIN 9714\Plan View\T 60x120x8
Alloy Profiles\DIN 9714\Plan View\T 60x120x10
Alloy Profiles\DIN 9714\Plan View\T 70x70x6
Alloy Profiles\DIN 9714\Plan View\T 70x70x8
Alloy Profiles\DIN 9714\Plan View\T 70x140x10
Alloy Profiles\DIN 9714\Plan View\T 70x140x12
Alloy Profiles\DIN 9714\Plan View\T 80x80x7
Alloy Profiles\DIN 9714\Plan View\T 80x80x9

(1536 symbols)

